

Application Note
3PASS and its
Application in
Handset and
Hands-Free
Testing



HEAD acoustics
Documentation

This documentation is a copyrighted work by HEAD acoustics GmbH.

The information and artwork in this documentation are the property of HEAD acoustics GmbH and shall not be reproduced or copied or used in whole or in part without written permission.

Copyright 2016 by HEAD acoustics GmbH.

All Rights Reserved.

AACHENHEAD[®] is a registered trademark.

HEAD acoustics[®] is a registered trademark.

This information may be subject to change.

All other brand and product names are trademarks and/or registered trademarks of their respective owners.

Rev0 (03/2016)

 **HEAD acoustics** GmbH
Ebertstraße 30a
D-52134 Herzogenrath
Tel: +49 (0) 2407-577-0
Fax: +49 (0) 2407-577-99
E-mail: telecom@head-acoustics.de
WEB: www.head-acoustics.de

Application Note 3PASS and its Application in Handset and Hands-Free Testing

Contents

1	PURPOSE.....	5
2	PART 1: SPEECH QUALITY MEASUREMENTS IN BACKGROUND NOISE USING DIFFERENT SOUND FIELD REPRODUCTION TECHNIQUES AND HANDSET POSITIONS.....	5
2.1	TEST SETUP.....	6
2.2	EQUALIZATION.....	9
2.2.1	<i>Equalization results with 3PASS.....</i>	9
2.2.2	<i>Equalization results for HAE-BGN.....</i>	14
2.2.3	<i>Mouth calibration and equalization results.....</i>	14
2.3	POSITIONING OF THE HANDSETS.....	15
2.4	BACKGROUND NOISES.....	18
2.5	TEST RESULTS.....	18
2.5.1	<i>Spectral accuracy of the different reproduction systems – mock-up tests.....</i>	18
2.5.2	<i>Accuracy of sound field reproduction using different mobile phones.....</i>	24
2.6	SPEECH QUALITY IN BACKGROUND NOISE USING 3QUEST ACCORDING TO ETSI TS 103 106 31	
2.7	CONCLUSIONS OF THE MOBILE PHONE EXPERIMENT.....	47
3	PART 2: SPEECH QUALITY MEASUREMENTS IN BACKGROUND NOISE USING DIFFERENT SOUND FIELD REPRODUCTION TECHNIQUES AND HANDS-FREE TERMINALS.....	48
3.1	TEST SETUP.....	48
3.2	EQUALIZATION.....	52
3.3	TEST RESULTS HAND-HELD HANDS-FREE (HHHF).....	56
3.3.1	<i>Comparison of Rooms.....</i>	56
3.3.2	<i>Comparison of average S- N- and G-MOS results in different rooms using 3PASS and HAE-BGN.....</i>	63
3.3.3	<i>Analyses of the noise spectra reproduced at the reference microphone.....</i>	65
3.3.4	<i>Simulation & noises acc. to TS 103 224.....</i>	69
3.4	TEST RESULTS DESKTOP HANDS-FREE (DTHF).....	72
3.4.1	<i>Comparison of Rooms.....</i>	72

3.4.2	<i>Comparison of average S- N- and G-MOS results in different rooms using 3PASS and HAE-BGN Comparison of equalization methods.....</i>	79
3.4.3	<i>Analyses of the noise spectra reproduced at the reference microphone.....</i>	80
3.5	CONCLUSIONS FROM THE HANDS-FREE TESTS.....	82
4	REFERENCES.....	83

1 Purpose

This application note is targeted to provide information on the accuracy of sound field reproduction when using 3PASS as standardized in ETSI TS 103 224 [2] when applying this technology to the measurement of handset type phones, mobile phones and hands-free phones including handheld hands-free phones.

A comparison to the previous sound-field simulation technique HAE-BGN as standardized in [1] is provided and the superiority of 3PASS with regard to spatial, temporal and spectral accuracy is shown.

Besides the evaluation of the accuracy of the sound-field reproduction at the location of the terminals the speech quality in sending is evaluated using 3QUEST [3] – the worldwide standardized method to evaluate speech and noise transmission quality in the presence of background noise. Differences observed due to different background noise simulation techniques are shown.

For mobile terminals the measurements of positional robustness in sending with and without background noise using the HHP IV handset positioner “MotoMount” and 3QUEST according to ETSI TS 103 106 [3] are provided and the results discussed.

It is the aim of this application note to create awareness of the different impacting factors when developing terminals and optimizing noise cancellation of the different types of terminals. The application note shows the setups to be used and introduces the different effects of signal processing and terminal designs which can be observed with modern, state of the art phones.

2 Part 1: Speech Quality Measurements in Background Noise Using Different Sound Field Reproduction Techniques and Handset Positions

The investigations in the experiments described in this chapter are targeted to

- The evaluation of the sound-field reproduction accuracy of the two simulation methods 3PASS and HAE-BGN.
- The evaluation of the position-dependent sound-field reproduction accuracy when using different positions than the nominal test positions for mobile phones at HATS.
- The positional robustness performance of different state of the art mobile phones.

Since the accuracy of the sound-field reproduction systems when deployed in different rooms are already described in the ETSI standards TS 103 224 [2] and ES 202 396-1 [1] no different rooms were used in these investigations. When comparing [1] and [2] it can be seen that the background noise sound field reproduction method in [2] provides a much higher accuracy across rooms including a generally higher spatial accuracy of the sound-field reproduction around the HATS. Therefore, additional validation in different rooms is not required.

2.1 Test setup

The setup for the 3PASS 8 channel sound-field simulation technique is described in detail in TS 103 224 [2] and in the 3PASS manual [8]. The equalization procedure is completely automated, no manual post-equalization is required. When using the HAE-BGN 4.1 sound-field simulation technique as described in ETSI ES 202 396-1 [1] a manual post equalization is required as described in [1] and in the HAE-BGN manual [9]. For both simulation techniques specific room requirements have to be respected as described in the ETSI standards.

In our experiment the room in which the measurements were made had a clarity (C80) of 37.1 dB and a reverberation time (RT60) of 125 ms. The room size was as follows: Length: 3.3m; Width: 2.4m; Height: 2.03m.

Two different background noise methods were used:

- 3PASS - 8-speaker method (ETSI TS 103 224, [2]) using the background noises from the ETSI TS 103 224 background noise database.
- HAE-BGN - 4.1 loudspeaker method (ETSI ES 202 396-1, [1]) *using the same noise scenarios as in TS 103 224* (binaurally recorded background noises in chapter 8.2 of EG 202 396-1 (noises equivalent to TS 103 224)), for handset DUT (**D**evice **U**nder **T**est) position. These background noises can be found in the ETSI ES 202 396-1 background noise database.

The room setup can be seen in **Figure 1**.

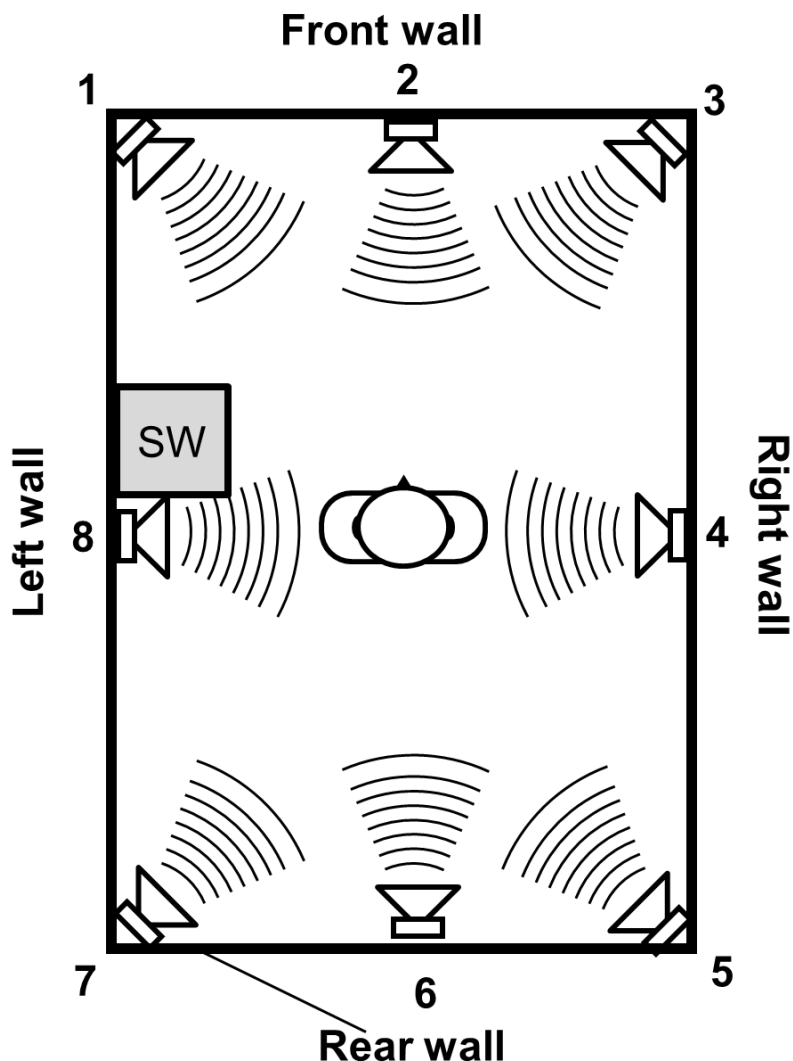

Figure 1: Speaker placement in room

Loudspeakers 1,3,5,7 were positioned in the corners of the room whereas loudspeakers 2, 4 and 8 were positioned in the midway on the edges. Because of the door of the room loudspeaker 6 is shifted slightly to the right. The subwoofer was positioned about 1 m from the front wall.

The HATS was located in the center of the room.

ACQUA with the HAE-BGN and 3PASS for background noise reproduction were used in combination with Nubert loudspeakers (nuLine 24, WS-203, nuBox 381) and a HEAD acoustics HSW 2.1 subwoofer for the 4.1 method. The speakers heights were as follows: Speakers 1-4 (Nubert nuLine 24): top edge 152 cm, lower edge 126 cm. Speakers 5-8 (Nubert WS-203): top edge 137 cm, lower edge 99 cm.

The tests were conducted with the HEAD acoustics HATS HMS II.3 equipped with the automated handset positioner HHP IV *MotoMount*.

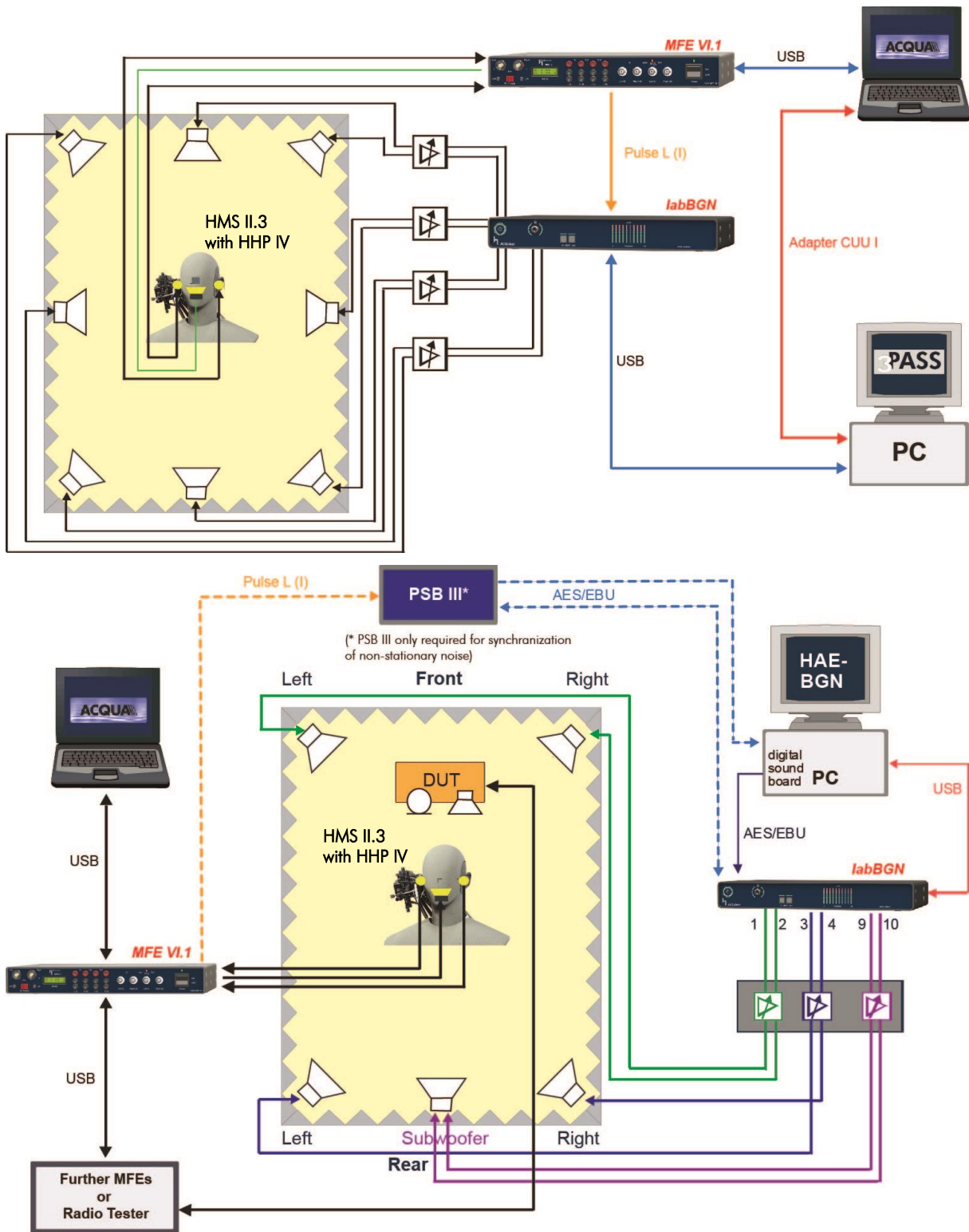

Figure 2: Setup of the test system and the background noise simulation systems 3PASS and HAE-BGN

The mouth simulator of the HATS was calibrated at MRP using a 1/2-inch pressure-field microphone.

For HAE-BGN the delays between the four loudspeakers which can be adapted to different rooms were chosen as follows:

- Front left: 0 ms, Front right: 11 ms
- Rear left: 17 ms, Rear right: 29 ms

These are the standard delays as described in [1].

In all of the rooms the HATS height was HRP 120 cm above the floor. The equalization was always done with HATS in place.

All measurements in this experiment were conducted in wideband.

2.2 Equalization

In this chapter we show the results of the equalization processes for both 3PASS and HAE-BGN. These are typical examples which can be used to double check own results. The 3PASS equalization procedure is completely automated. If the equalization procedure fails, additional treatment of the room is needed. This includes the validation of the C80 criterion and the reverberation time, the application of additional damping material and the change of the loudspeaker position.

The equalization with HAE-BGN requires manual post-equalization in order to minimize the cross-talk from the left channel signal to the right ear of the artificial head and vice versa. This procedure is described in the HAE-BGN manual [9]. If the equalization result is not satisfying, the delays between the loudspeakers and the loudspeaker positioning should be changed. The room treatment might need to be adapted in a similar way as it is described above for 3PASS.

2.2.1 Equalization results with 3PASS

Report for Filter Validation "Filter Validation"

Settings of Setup "3PASS_akt"

Comment	3PASS_akt
Lower Frequency bound	50 Hz
Higher Frequency bound	20000 Hz
Setup Creation	06.01.2016 14:15:09
Last Equalization	06.01.2016 14:25:55

Measured impulse responses

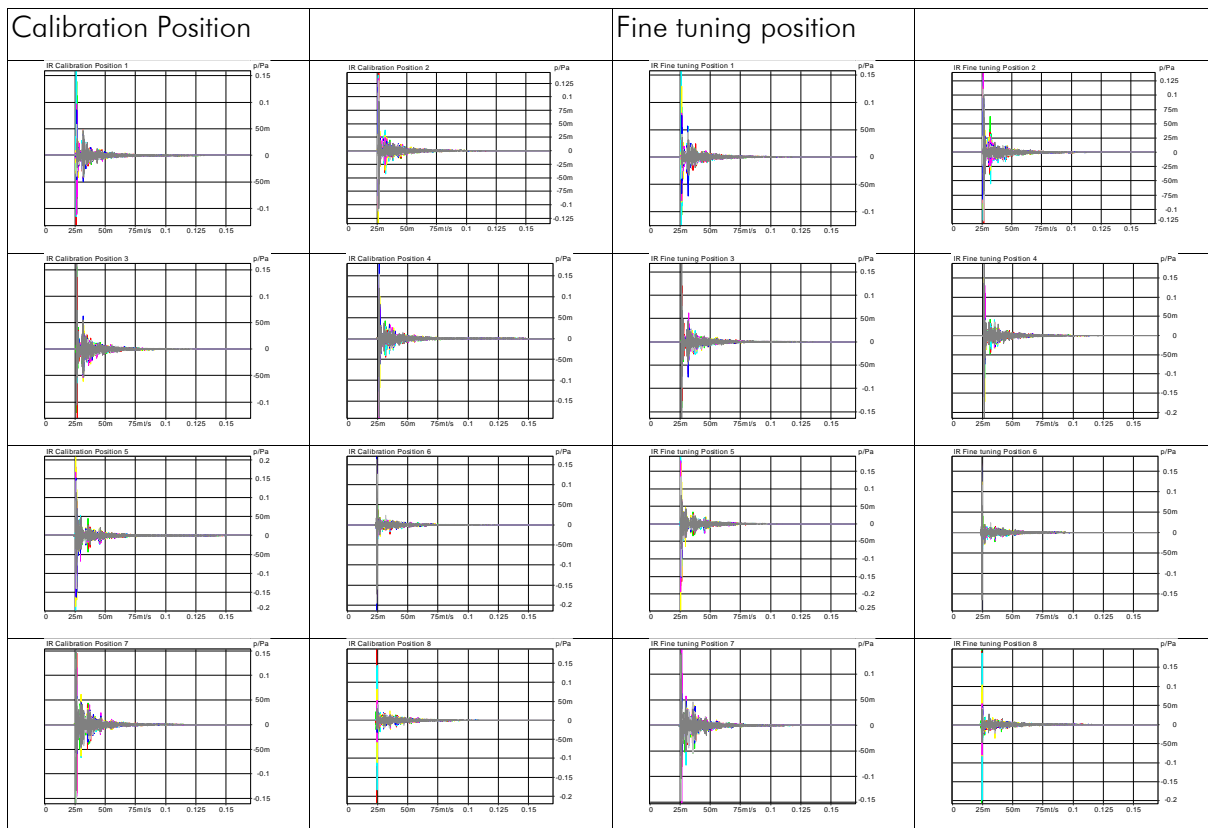

Impulse responses of filters

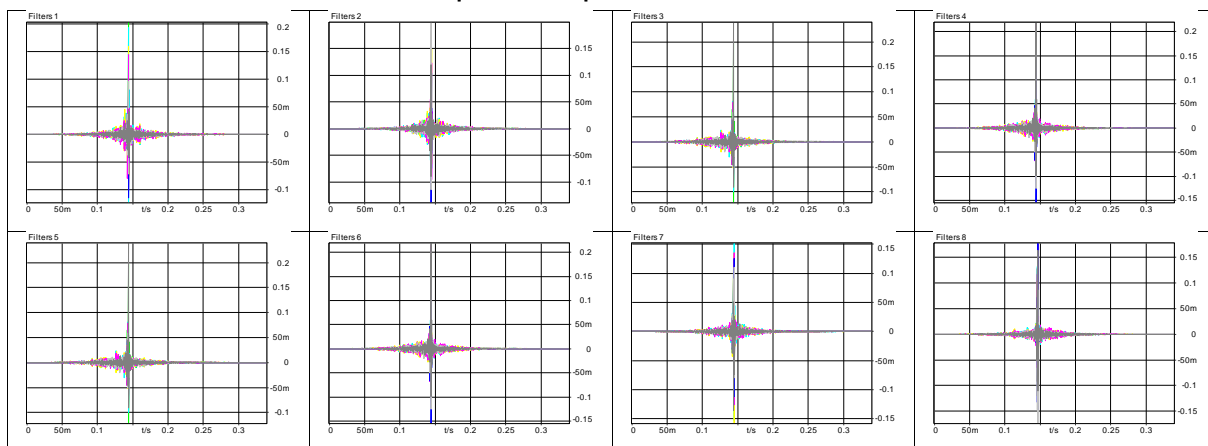

Filter Validation

Name	Filter Validation
Comment	
Date and Time of Check	06.01.2016 14:34:41
Overall Equalization Result	OK

Level Deviations

	Mic 1	Mic 2	Mic 3	Mic 4	Mic 5	Mic 6	Mic 7	Mic 8
Calibration pos	0,12	0,16	0,18	0,12	0,13	-0,47	0,30	-0,17
Fine tuning pos	0,17	0,26	0,23	0,17	0,13	-0,50	0,49	-0,33

Results of single accuracy checks

Frequency Response I	50 Hz	10000 Hz	OK	Calibration position
Frequency Response II	10000 Hz	16000 Hz	OK	Calibration position
Average Frequency Response	50 Hz	20000 Hz	OK	Calibration position
Mag. of Complex Coherence	100 Hz	1000 Hz	OK	Calibration position
Phase of Complex Coherence I	100 Hz	1000 Hz	OK	Calibration position
Phase of Complex Coherence II	1000 Hz	1500 Hz	OK	Calibration position
Frequency Response I	50 Hz	10000 Hz	OK	Fine tuning position
Frequency Response II	10000 Hz	16000 Hz	OK	Fine tuning position
Average Frequency Response	50 Hz	20000 Hz	OK	Fine tuning position
Mag. of Complex Coherence	100 Hz	1000 Hz	OK	Fine tuning position
Phase of Complex Coherence I	100 Hz	1000 Hz	OK	Fine tuning position
Phase of Complex Coherence II	1000 Hz	1500 Hz	OK	Fine tuning position

Diagrams of the validation results

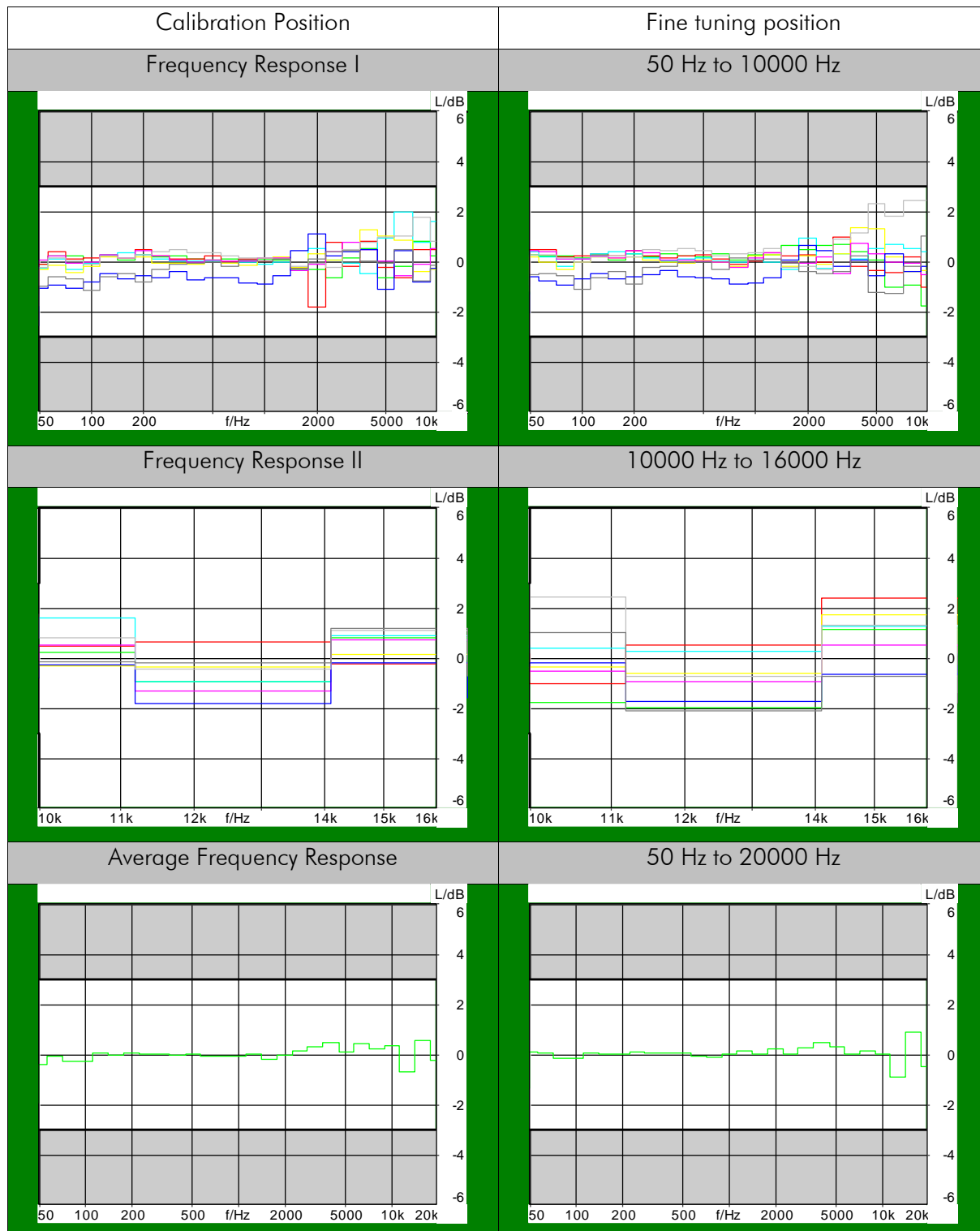

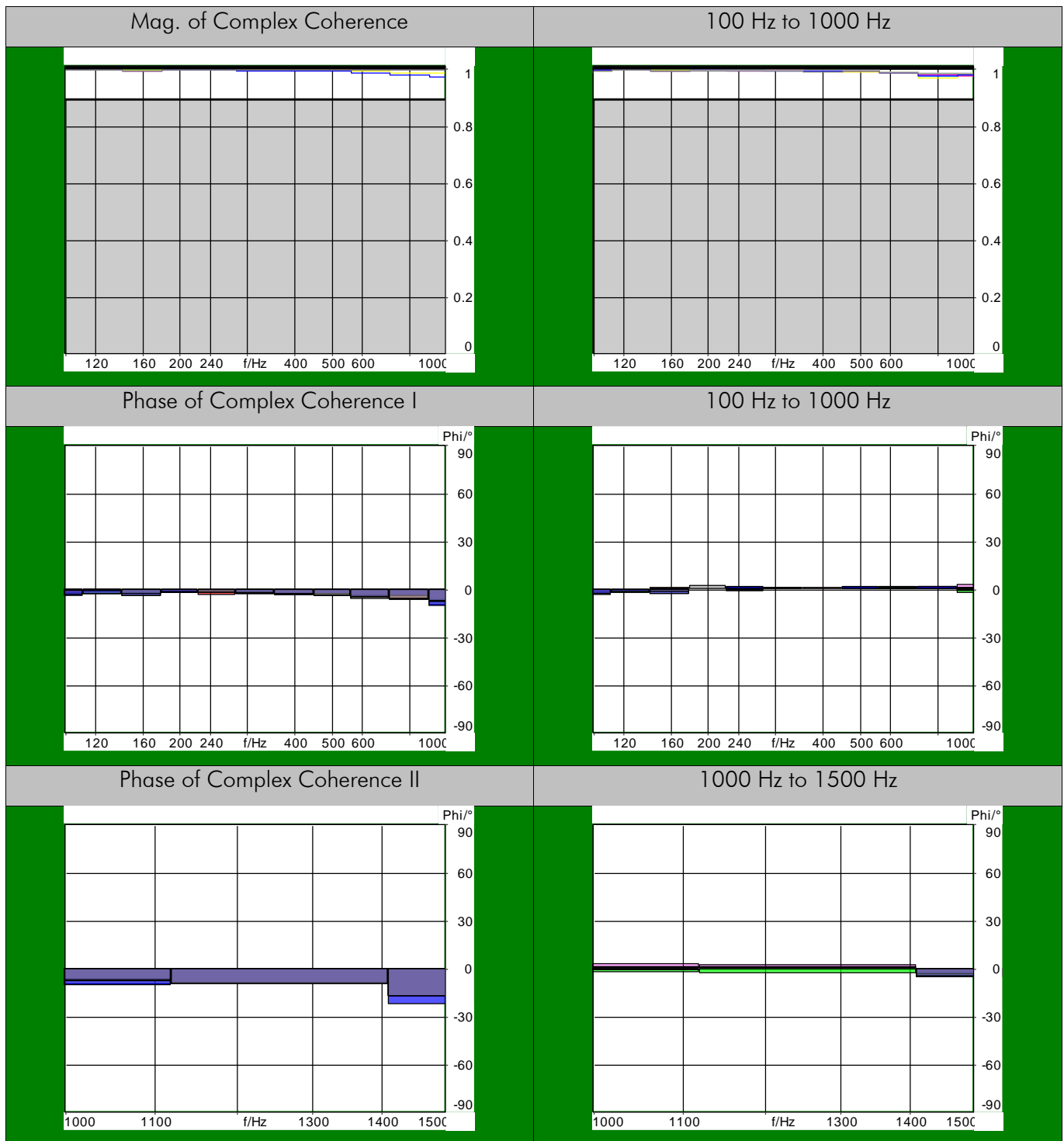

Figure 3: Equalization results TS 103 224

2.2.2 Equalization results for HAE-BGN

The equalization check of HAE-BGN is only based on the validation of the averaged spectra of the left and the right ear signal. The result of our experiment is shown in **Figure 4**.

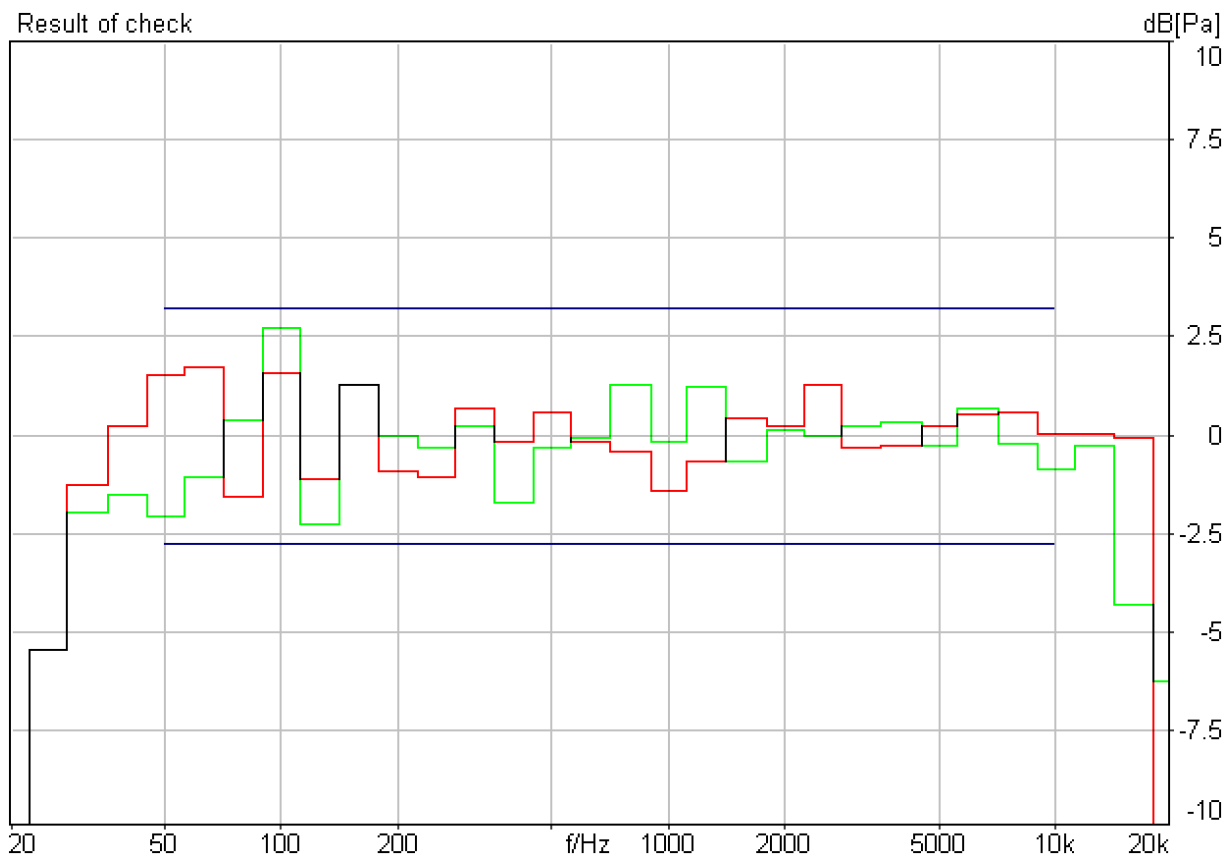

Figure 4: Equalization results ES 202 396-1

2.2.3 Mouth calibration and equalization results

Besides the validation of the background noise fields, the correct calibration and equalization of the artificial mouth of the HMS II.3 is required. Whereas the equalization for the background noise sound fields is always from 20 Hz to 20 kHz, the mouth equalization may be limited in bandwidth depending on the type of terminal tested. In general, the equalization should be performed at least up to 10 kHz when testing narrowband and wideband terminals. For super-wideband and fullband terminals the equalization range must be adapted accordingly. In our experiment which was covering wideband terminals, the frequency range for the mouth equalization was 50 Hz to 14000 Hz.

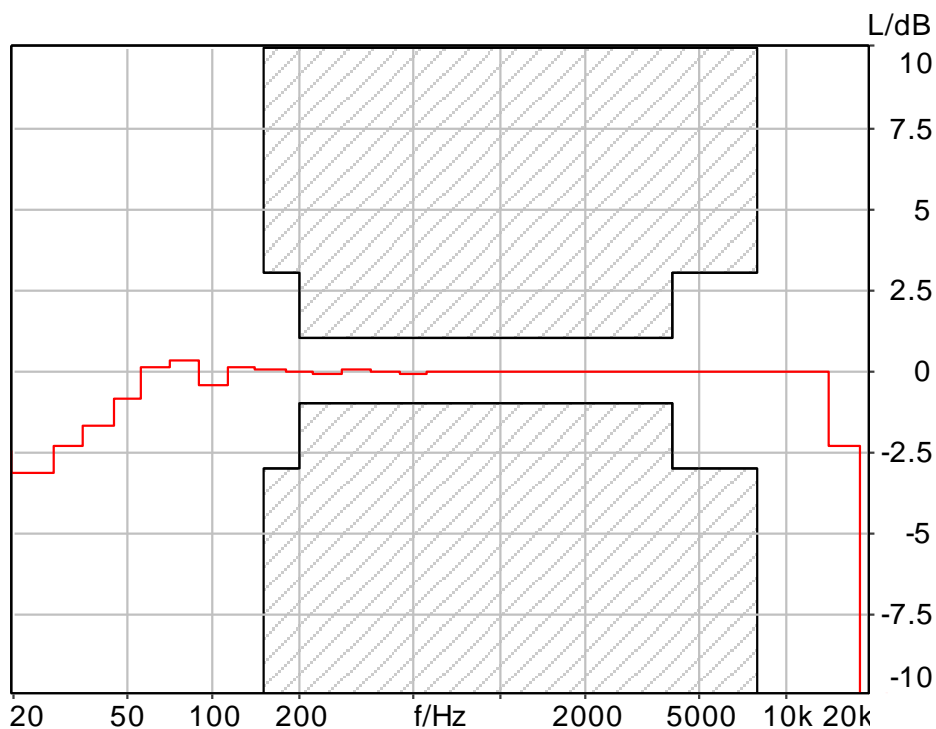

Figure 5: Mouth equalization result

2.3 Positioning of the handsets

The positioning of terminals at a Head and Torso Simulator (HATS) is described in Recommendation ITU-T P.64 [6].

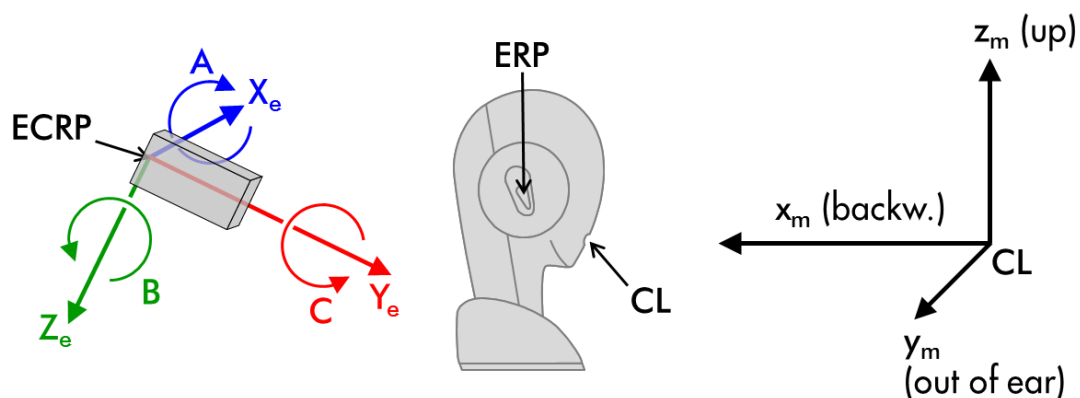

Figure 6: Illustration of the coordinate systems according to ITU-T P.64

Figure 7 shows the positionings of the phone used in our experiment on the HATS. In Figure 8 the mock-up used in the experiments is shown. Besides the mock-up three different actual mobile phones were used.

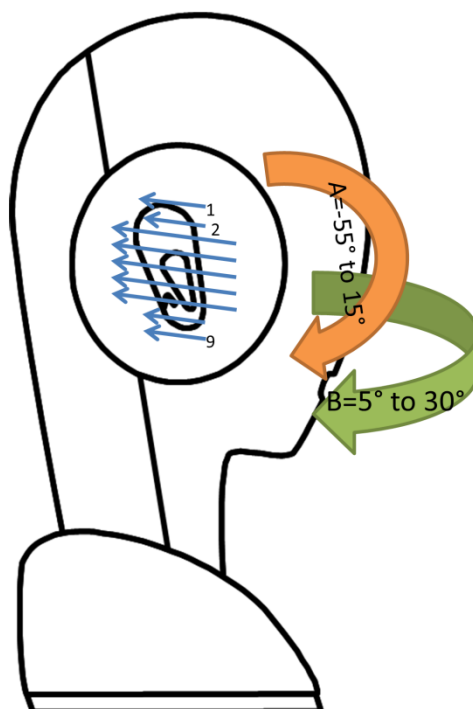

Figure 7: Positioning of the mock up on HATS and angles of rotation (qualitatively)

Figure 7 illustrates the angles of rotation used in the experiment (see also Figure 6). In total 81 positions were used in this experiment:

- 10x a reference position to validate if something has changed which influences the measurement results in addition to the different positions ($X_e=0$, $Y_e=0$, $Z_e=0$, $A=0$, $B=5^\circ$, $C=0$, $Y_m=30\text{mm}$)
- 8x different A angle positions ($A=-55^\circ$ to 15°)
- 6x different B angle positions ($B=5^\circ$ to 30° with $X_e=-10\text{mm}$)
- Remaining positions distributed around ear (cf. Figure 7)

For each position the sound field was recorded at the main microphone position (Figure 8, microphone 1) and at a secondary microphone position located at the opposite corner of the main microphone on the back of the mock-up (Figure 8, microphone 7).

The positions 0° , up, down and out used in some of the following diagrams are defined as follows:

Detailed Position

0°	$X_e=0$, $Y_e=0$, $Z_e=0$, $A=0$, $B=5^\circ$, $C=0$, $Y_m=0$
Up	$X_e=0$, $Y_e=0$, $Z_e=0$, $A=-55^\circ$, $B=5^\circ$, $C=0$, $Y_m=0$
Down	$X_e=0$, $Y_e=0$, $Z_e=0$, $A=15^\circ$, $B=5^\circ$, $C=0$, $Y_m=0$
Out	$X_e=-10\text{mm}$, $Y_e=0$, $Z_e=0$, $A=0$, $B=30^\circ$, $C=0$, $Y_m=0$

Table 1: Detailed description of the positions

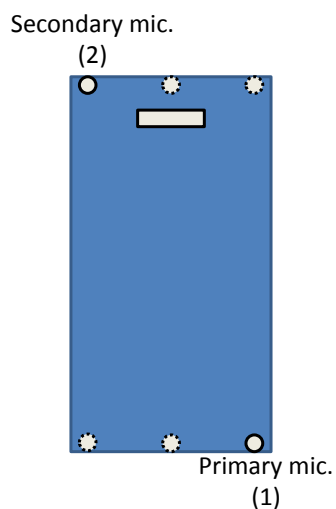

Figure 8: Schematics of the mock up (120 x 65 x 10mm) and the microphone positions used. The figure shows a drawing of the mock-up. For the experiments microphones 1 and 2 were used as primary microphone/secondary microphone respectively.

Besides the mock-up the following mobile phones were used:

	Dimensions	RF Connection
Phone 1	138.1 x 67 x 6.9 mm	3G
Phone 2	138.5 x 70.9 x 8.9 mm	3G
Phone 3	127 x 65 x 8.9 mm	3G

Table 2: Phones used in the test

All phones were connected to a radio network simulator. The setup as defined in 3GPP TS 26.131 and TS 26.132 was used. For the background noise tests the speech level was -1.7 dBPa.

All experiments using the mobile phones were conducted in wideband using AMR-WB at 12.65 kbit/s.

2.4 Background noises

In our experiments the following background noises defined in TS 103 224 [2] and their equivalent binaural noises as defined in ES 202 396-1 [1] were used:

Name	Description	Length	Handset Levels
Inside Car Noise			
Full-size car 130 km/h (<i>FullSizeCar_130</i>)	HATS and microphone array at co-drivers position	30 s	1: 67.3 dB 2: 68.1 dB 3: 67.8 dB 4: 68.3 dB 5: 68.9 dB 6: 69.5 dB 7: 69.8 dB 8: 70.3 dB
Outside Traffic Street Noise			
Crossroadnoise (<i>Crossroadnoise</i>)	HATS and microphone array standing outside near a cross-road	30 s	1: 69.1 dB 2: 69.8 dB 3: 69.1 dB 4: 69.9 dB 5: 69.2 dB 6: 70.0 dB 7: 69.9 dB 8: 69.7 dB
Public Places Noise			
Cafeteria (<i>Cafeteria</i>)	HATS and microphone array inside a cafeteria	30 s	1: 68.9 dB 2: 69.9 dB 3: 69.1 dB 4: 69.6 dB 5: 69.5 dB 6: 69.8 dB 7: 69.5 dB 8: 69.5 dB
Departure platform (<i>TrainStation</i>)	HATS and microphone array on the departure platform of a train station	30 s	1: 77.1 dB 2: 78.1 dB 3: 77.4 dB 4: 78.3 dB 5: 77.8 dB 6: 78.0 dB 7: 77.7 dB 8: 78.3 dB
Pub Noise (<i>Pub</i>)	HATS and microphone array in a pub	30 s	1: 76.0 dB 2: 76.3 dB 3: 74.5 dB 4: 74.7 dB 5: 74.7 dB 6: 75.1 dB 7: 74.8 dB 8: 74.7 dB
Workplace Noise			
Callcenter 2 (<i>Call-center</i>)	HATS and microphone array in business office	30 s	1: 59.0 dB 2: 59.8 dB 3: 58.9 dB 4: 59.6 dB 5: 59.1 dB 6: 59.4 dB 7: 59.0 dB 8: 59.0 dB

Table 3: Background noises used in the test

2.5 Test results

2.5.1 Spectral accuracy of the different reproduction systems – mock-up tests

For this experiment a *reference background noise field* was generated by positioning 8 loudspeakers arbitrarily in a room and playing back train station noise from TS 103 224. Recordings were made using the mock-up in order to determine the spectra of the sound field at the different positions in the reference situation.

In a second step, the sound field was recorded using MSA I in conjunction with the *labBGN* frontend and 3PASS. In parallel, the equalized output of the HATS was used in order to record the background noise for HAE-BGN.

These signals were then used for the reproduction of the reference sound field by 3PASS and HAE-BGN and for comparison to the *reference background noise field*.

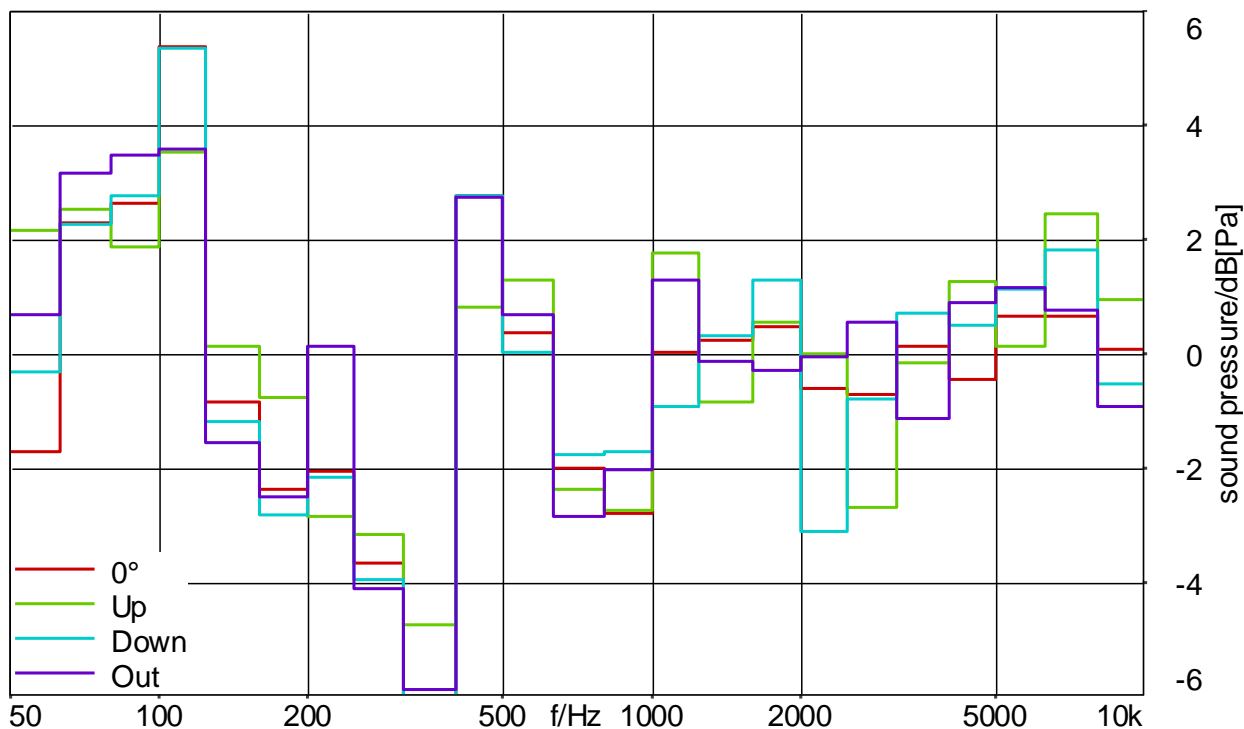

Figure 9: Differences between spectrum of the reference sound field and the reproduction using HAE-BGN at the primary microphone 1 for the 4 different positions 0°, up, down and out

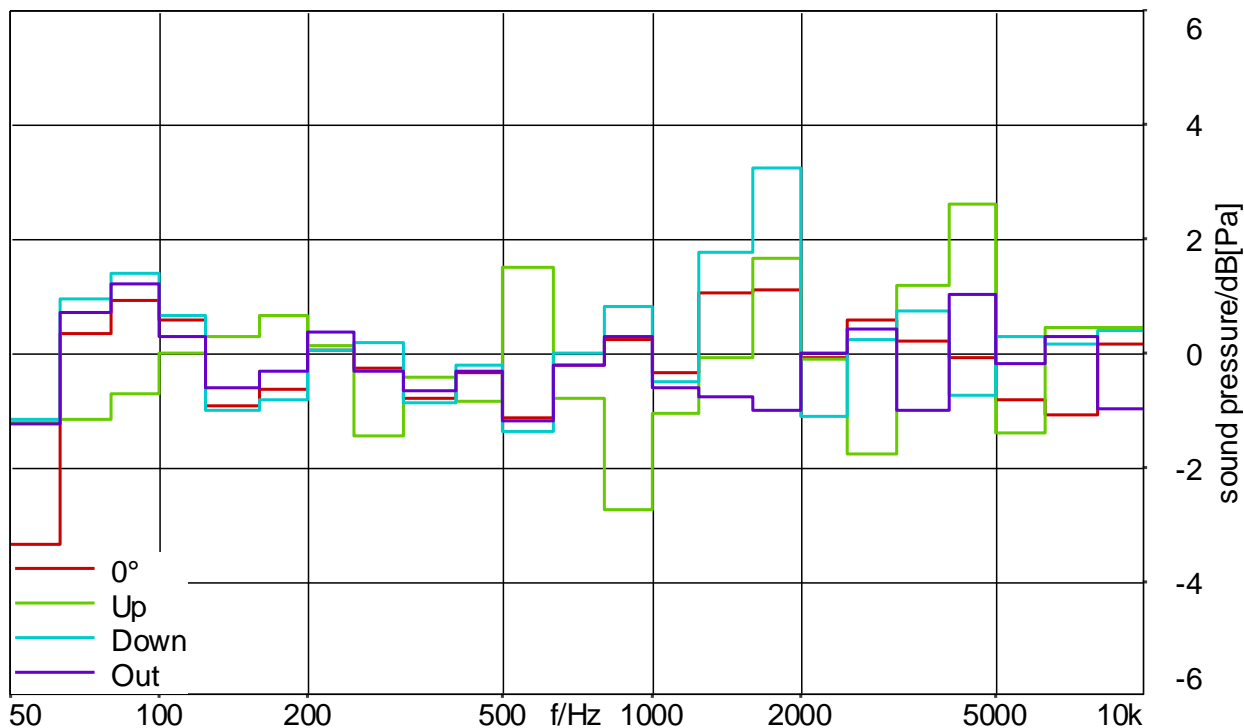

Figure 10: Differences between spectrum of the reference sound field and the reproduction using 3PASS at the primary microphone 1 for the 4 different positions 0°, up, down and out

Figure 9 and Figure 10 show the differences in accuracy when using the different sound field simulation methods. Especially in the frequency range from 20 Hz to 2 kHz where the maximum energy is found for most of the background noises, the reproduction accuracy of 3PASS is much higher for all positions of the mock-up at the primary microphone position. The same measurements were performed for the secondary microphone position as well (see Figure 11 and Figure 12). The same conclusion can be drawn for the secondary mike position. In consequence, a terminal under test will be exposed to a *much more realistic* sound field when using 3PASS in comparison to HAE-BGN.

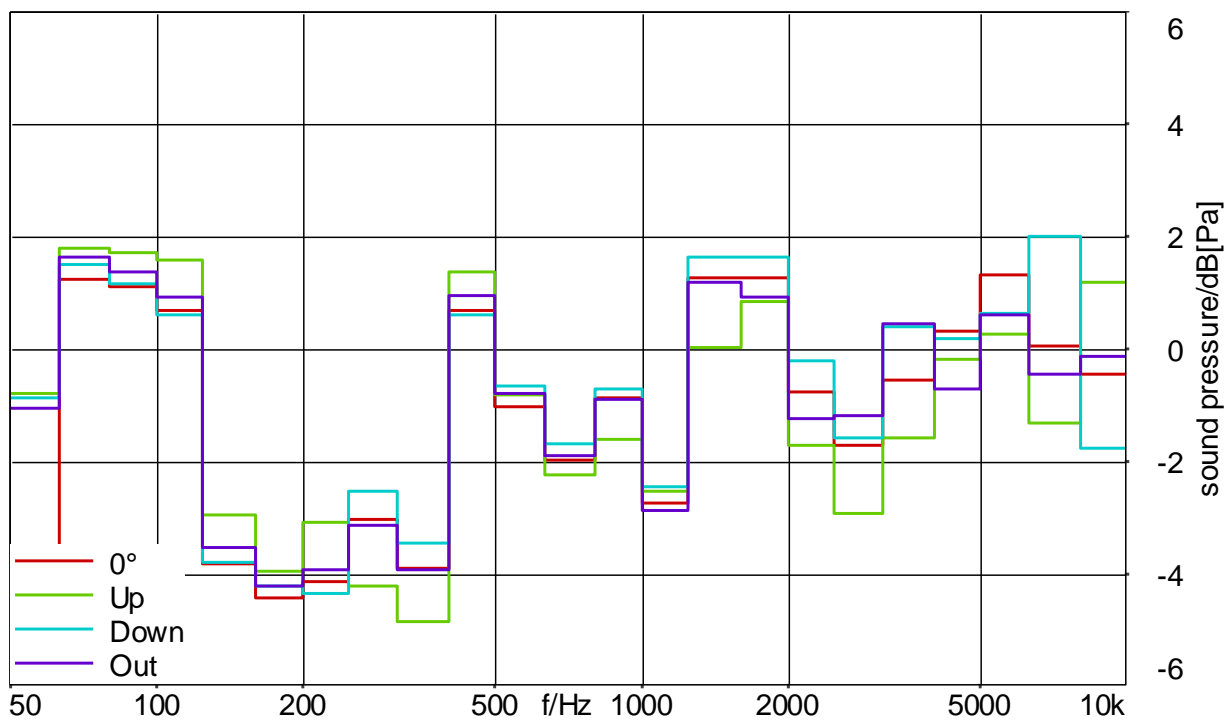

Figure 11: Differences between spectrum of the reference sound field and the reproduction using HAE-BGN at the secondary microphone 2 for the 4 different positions 0°, up, down and out

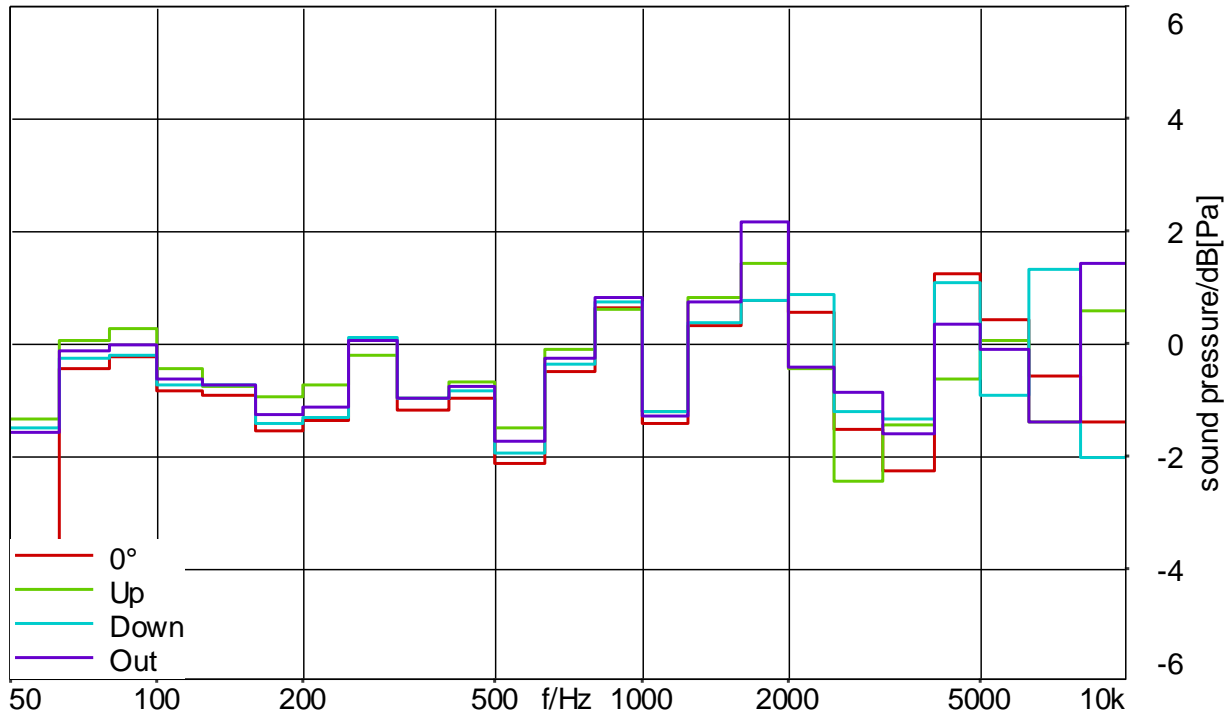

Figure 12: Differences between spectrum of the reference sound field and the reproduction using 3PASS at the secondary microphone 2 for the 4 different positions 0°, up, down and out

The test results for all 81 positions used in the tests compared to each reference are shown in Figure 13 to Figure 16. The conclusions drawn for the 4 positions discussed above can be drawn in the same way for all positions around the HATS tested in this experiment. 3PASS not only provides a higher accuracy of the sound field reproduction for the nominal handset positions, the same increase of accuracy can be achieved for all the typical positions needed for positional robustness testing.

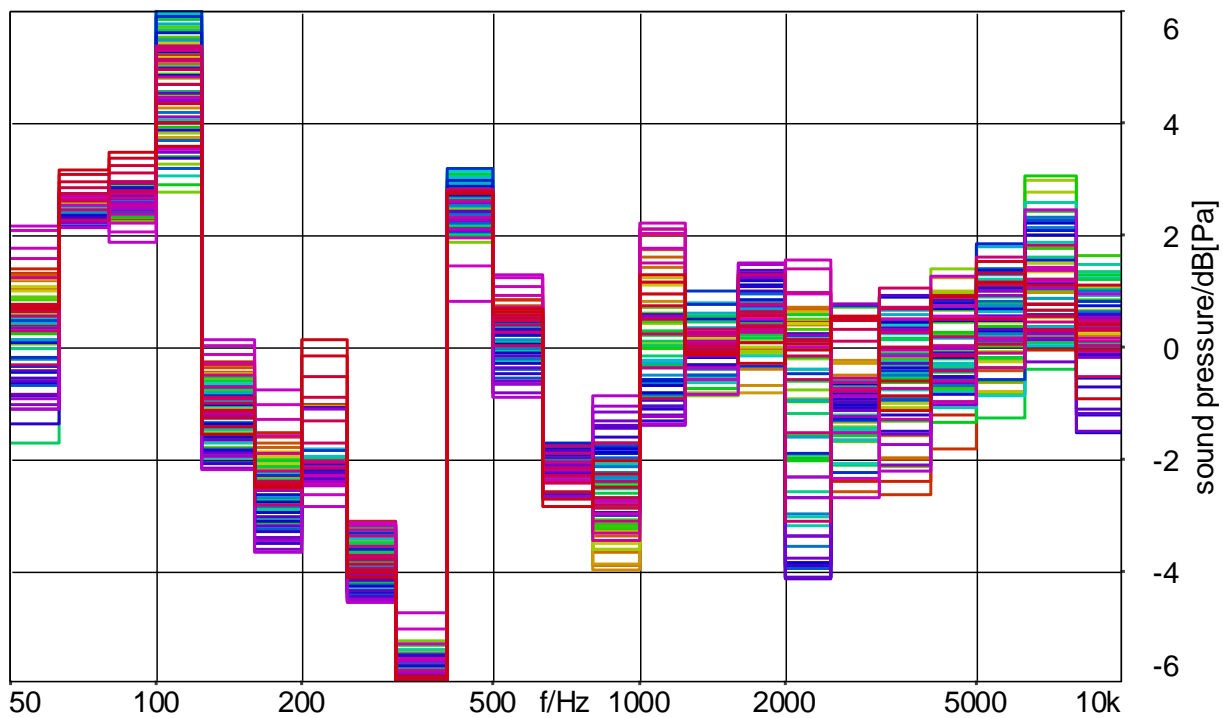

Figure 13: Differences between spectrum of the reference sound field at the primary microphone 1 for all positions and the reproduction using HAE-BGN

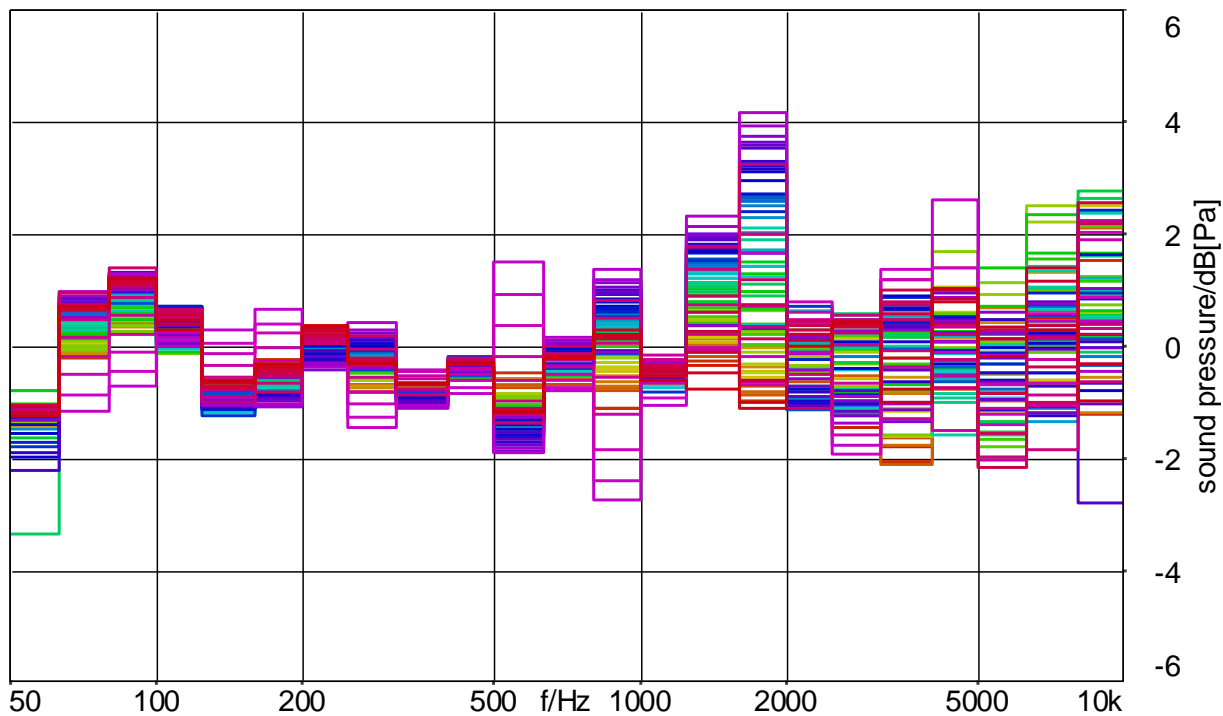

Figure 14: Differences between spectrum of the reference sound field at the primary microphone 1 for all positions and the reproduction using 3PASS

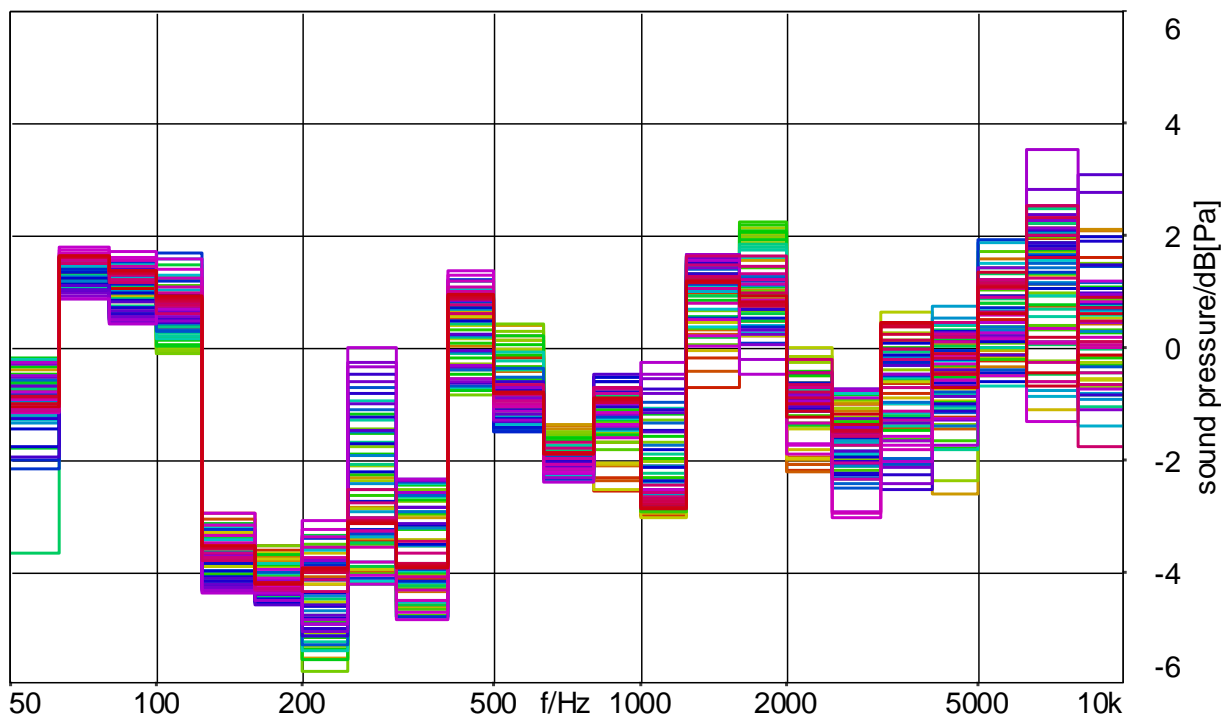

Figure 15: Differences between spectrum of the reference sound field at the secondary microphone 2 for all positions and the reproduction using HAE-BGN

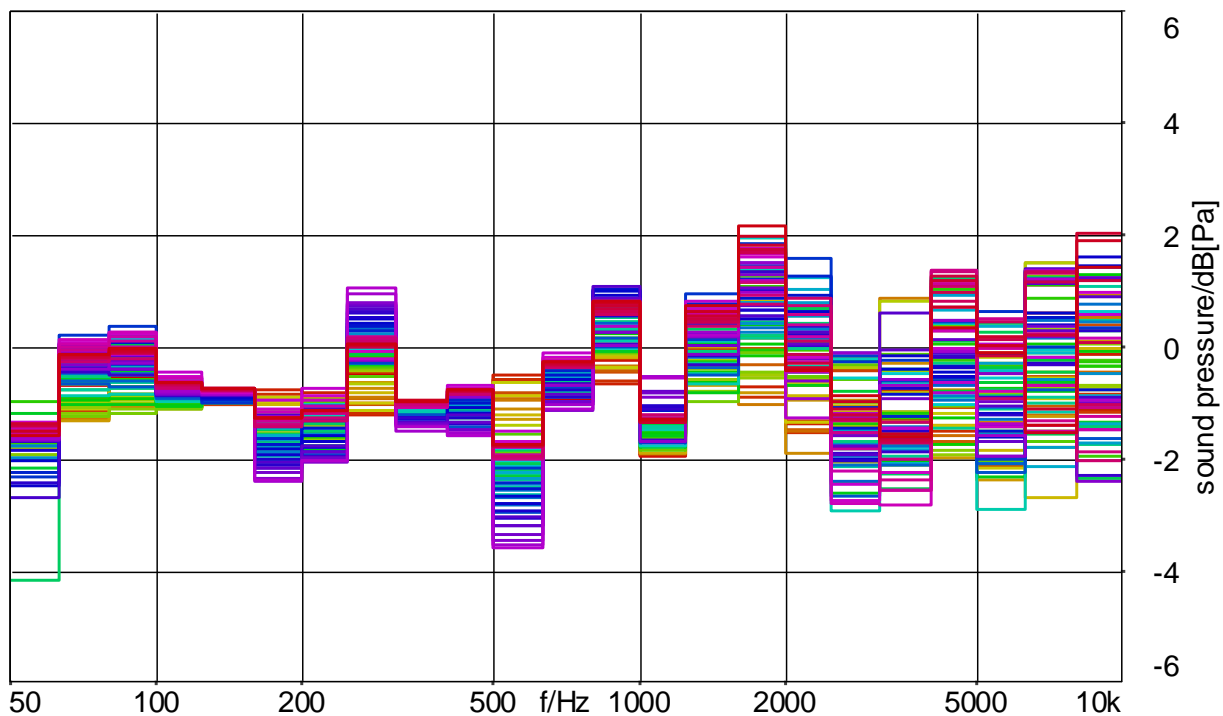

Figure 16: Differences between spectrum of the reference sound field at the secondary microphone 2 for all positions and the reproduction using 3PASS

2.5.2 Accuracy of sound field reproduction using different mobile phones

For this experiment 3 different actual mobile phones were used. The background noises used in this experiment are from TS 103 224 and their equivalent noises in ES 202 396-1. For this evaluation the microphone signals from microphones 3, 4 and 5 (see TS 103 224) which are closest to the region of the primary microphones of the mobile phones were averaged (in the following represented by the thick black curve) and used as the reference. These spectra are compared to unprocessed reference microphone (TS 103 106, colored curves) which is always positioned close to the terminals primary microphone and used for 3QUEST analyses.

For all noises and for all mobile phones the spectra recorded at the reference microphone match the averaged spectra of microphones 3, 4 and 5 of the microphone array much better when using the 3PASS simulation technology compared to the HAE-BGN simulation technology.

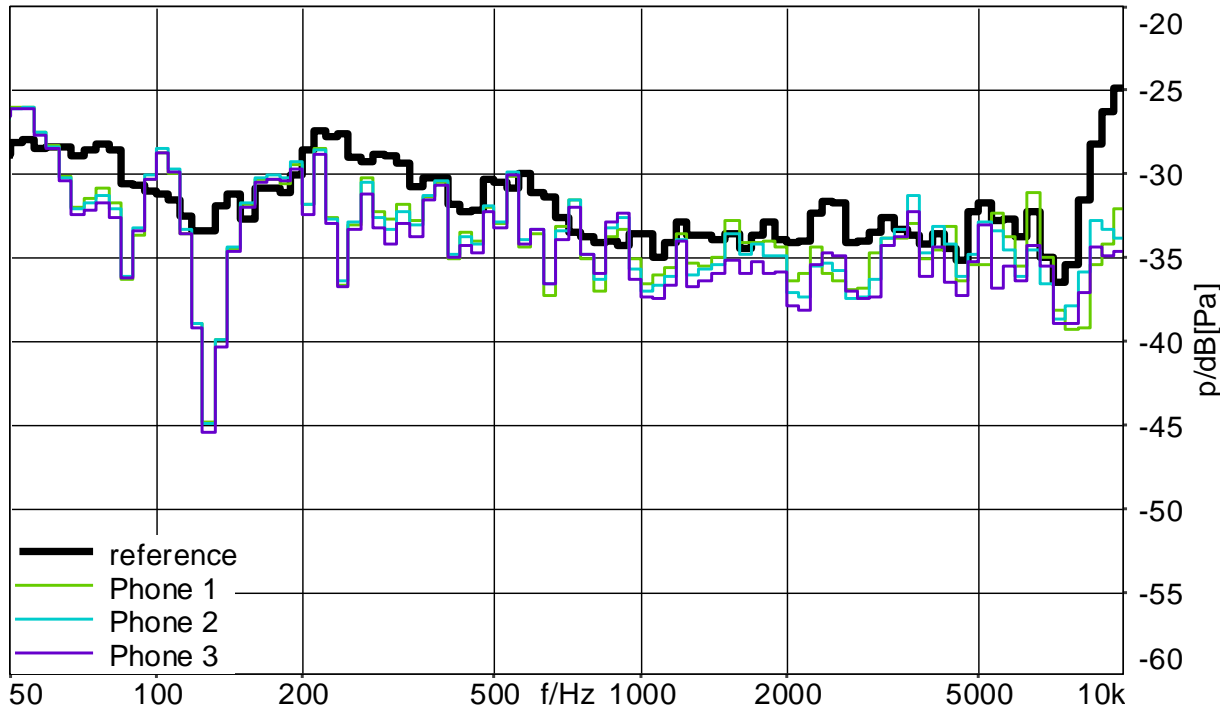

Figure 17: Averaged signal of mics 3,4,5 compared to the reference microphone spectrum recorded close to the terminal primary microphone position, HAE-BGN simulation method, Noise: trainstation

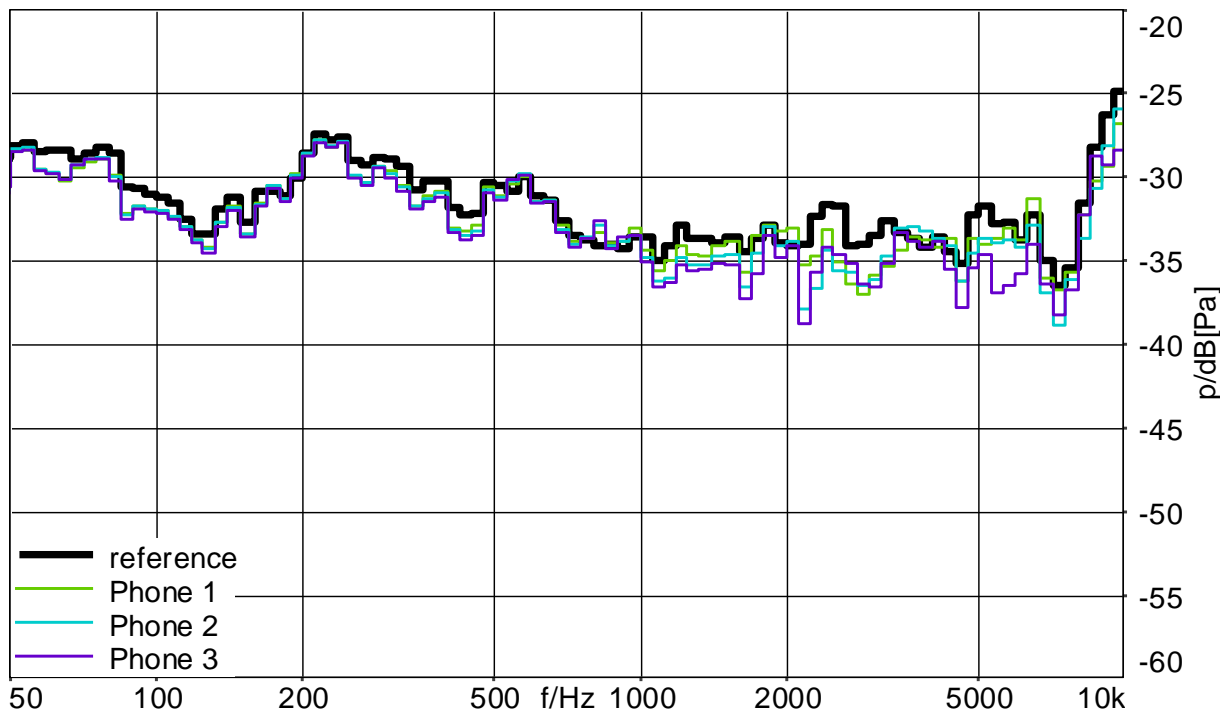

Figure 18: Averaged signal of mics 3,4,5 compared to the reference microphone spectrum recorded close to the terminal primary microphone position, 3PASS simulation method, Noise: trainstation

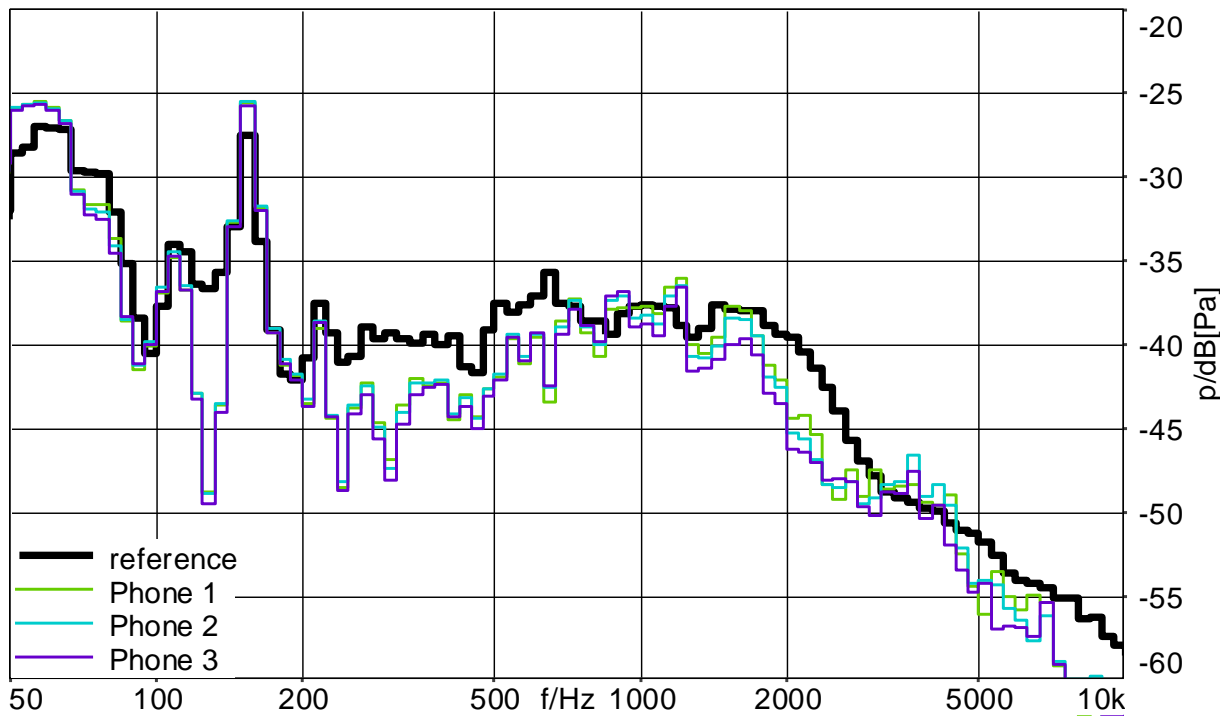

Figure 19: Averaged signal of mics 3,4,5 compared to the reference microphone spectrum recorded close to the terminal primary microphone position, HAE-BGN simulation method, Noise: crossroad

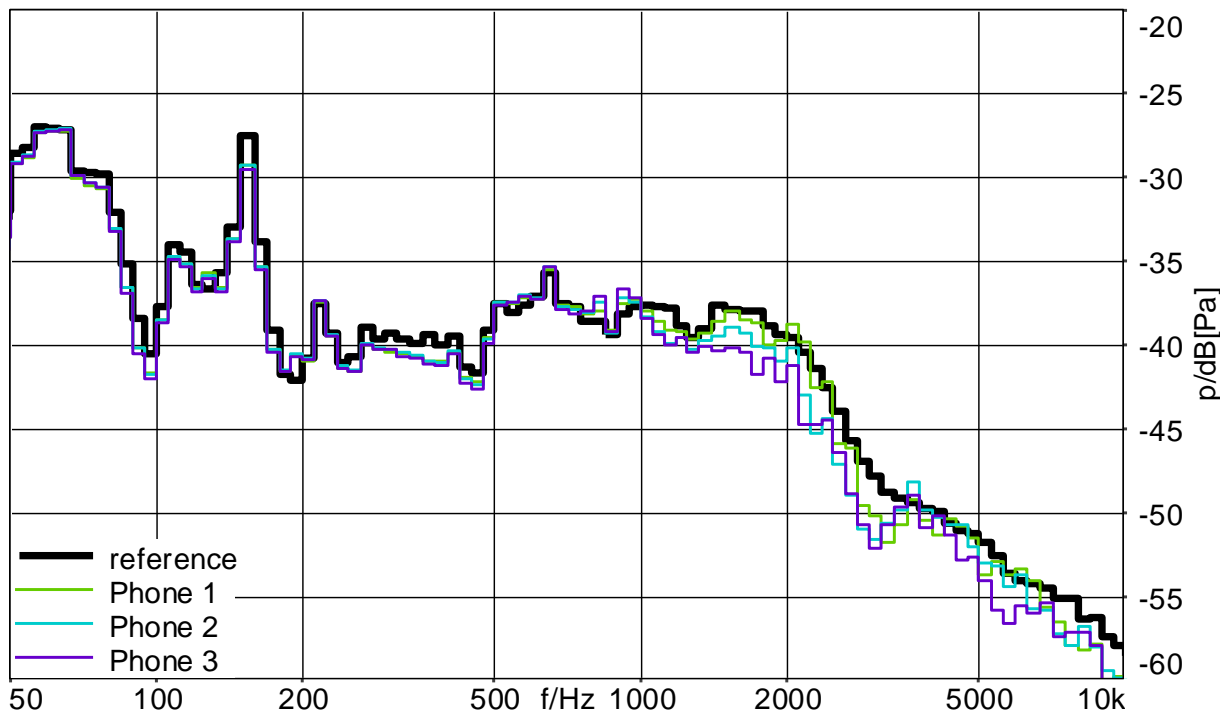

Figure 20: Averaged signal of mics 3,4,5 compared to the reference microphone spectrum recorded close to the terminal primary microphone position, 3PASS simulation method, Noise: crossroad

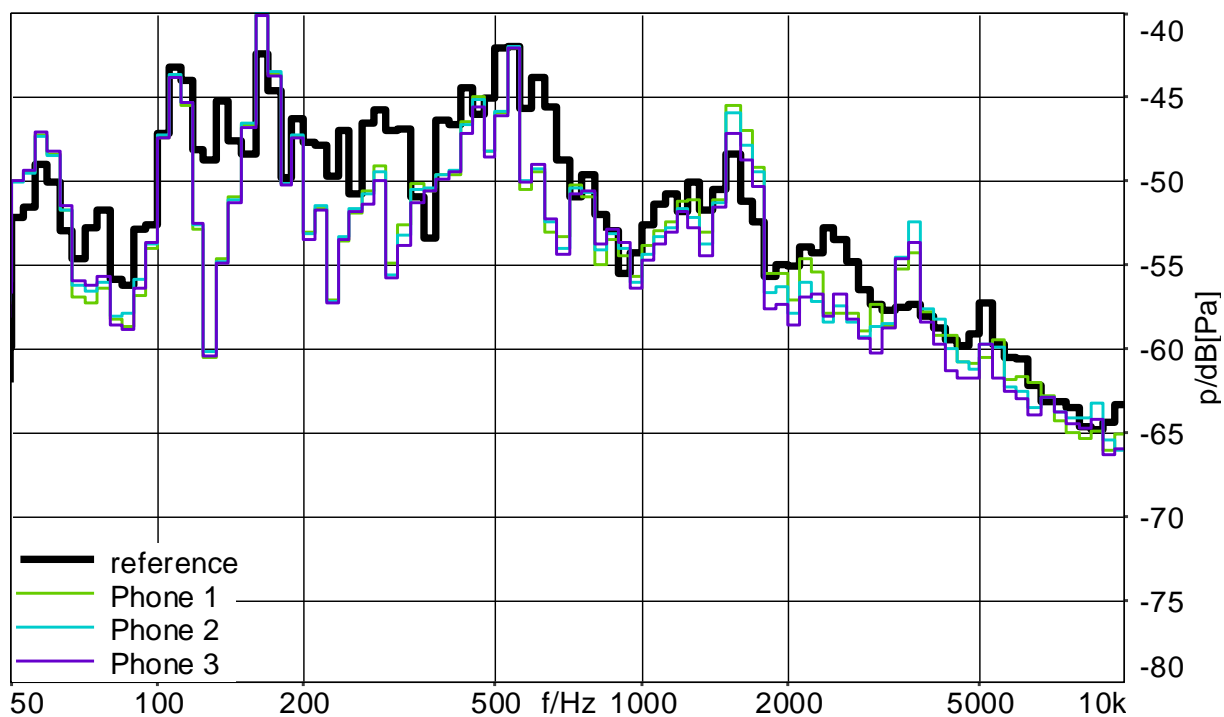

Figure 21: Averaged signal of mics 3,4,5 compared to the reference microphone spectrum recorded close to the terminal primary microphone position, HAE-BGN simulation method, Noise: office

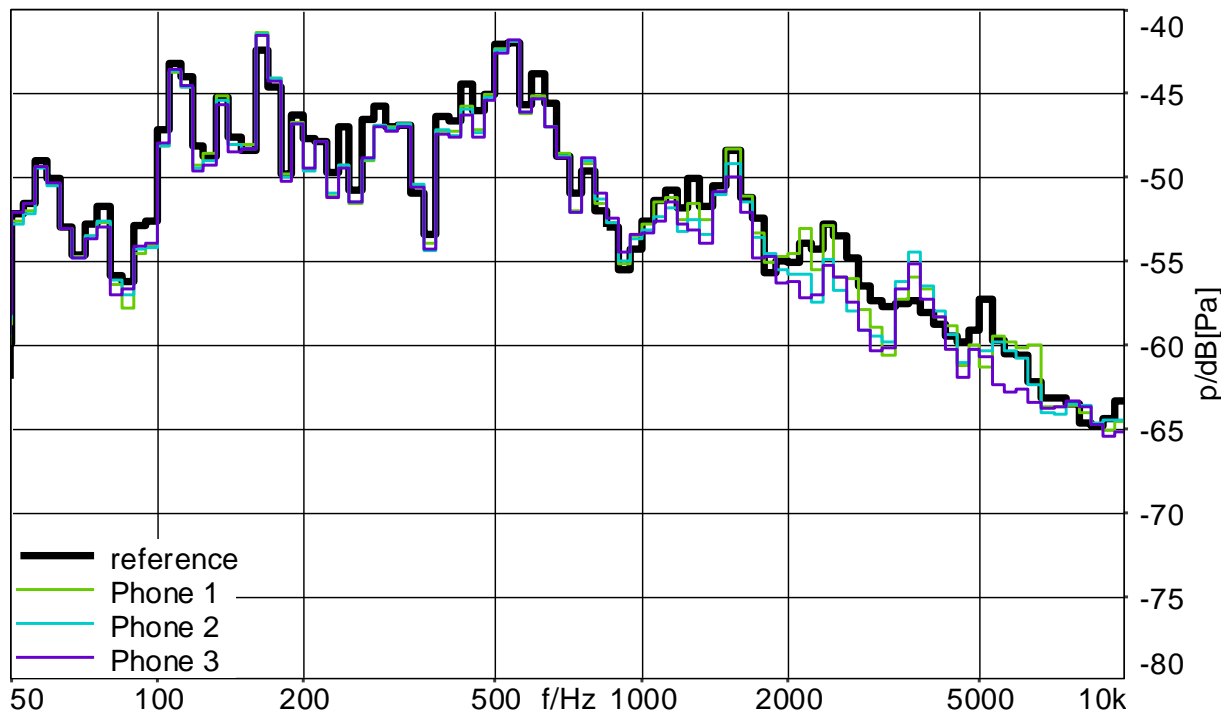

Figure 22: Averaged signal of mics 3,4,5 compared to the reference microphone spectrum recorded close to the terminal primary microphone position, 3PASS simulation method, Noise: office

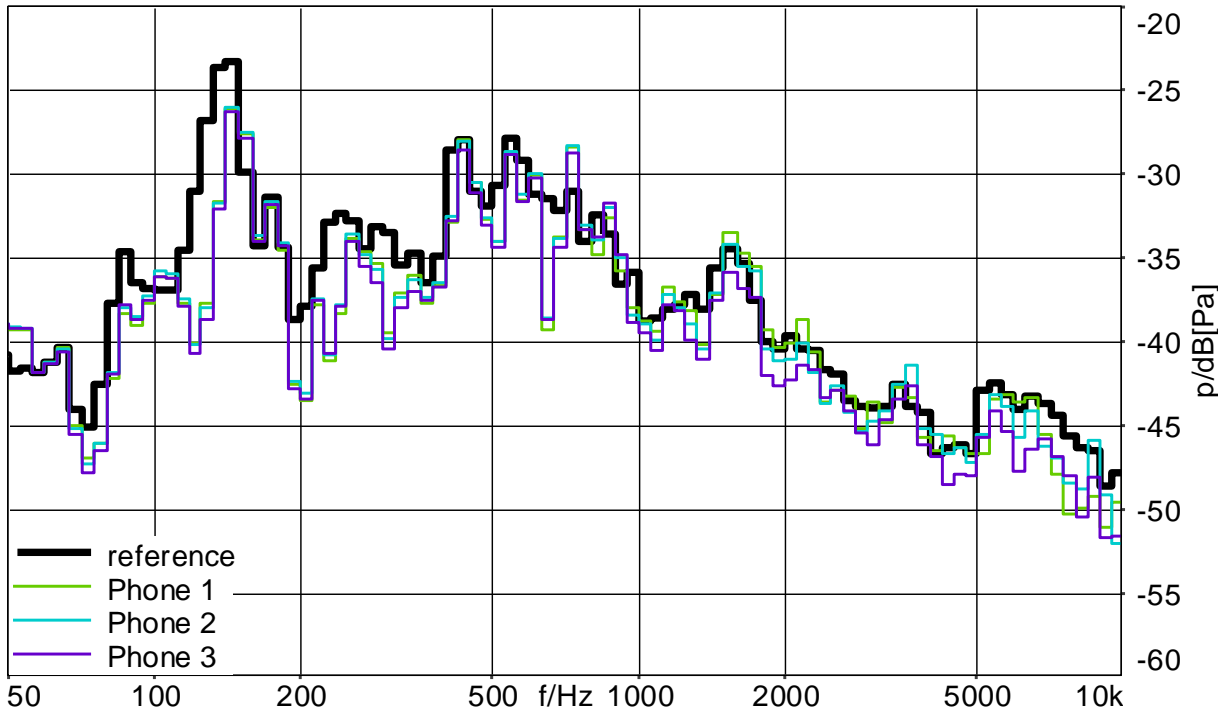

Figure 23: Averaged signal of mics 3,4,5 compared to the reference microphone spectrum recorded close to the terminal primary microphone position, HAE-BGN simulation method, Noise: pub

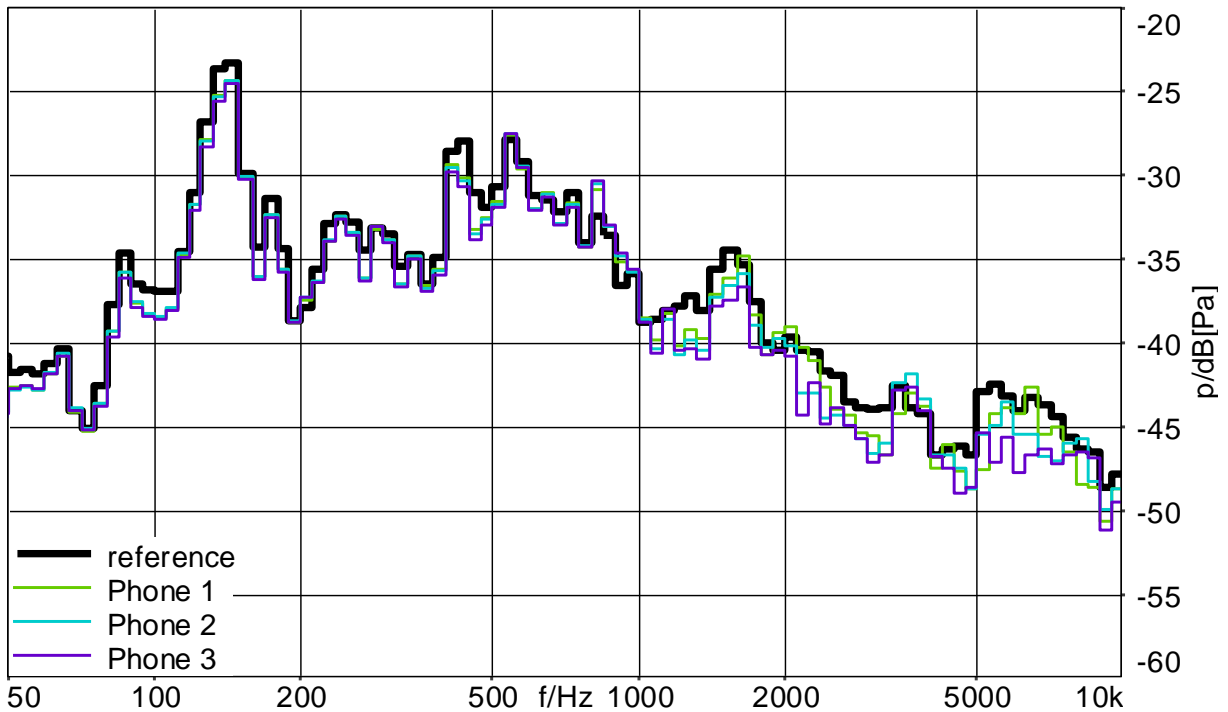

Figure 24: Averaged signal of mics 3,4,5 compared to the reference microphone spectrum recorded close to the terminal primary microphone position, 3PASS simulation method, Noise: pub

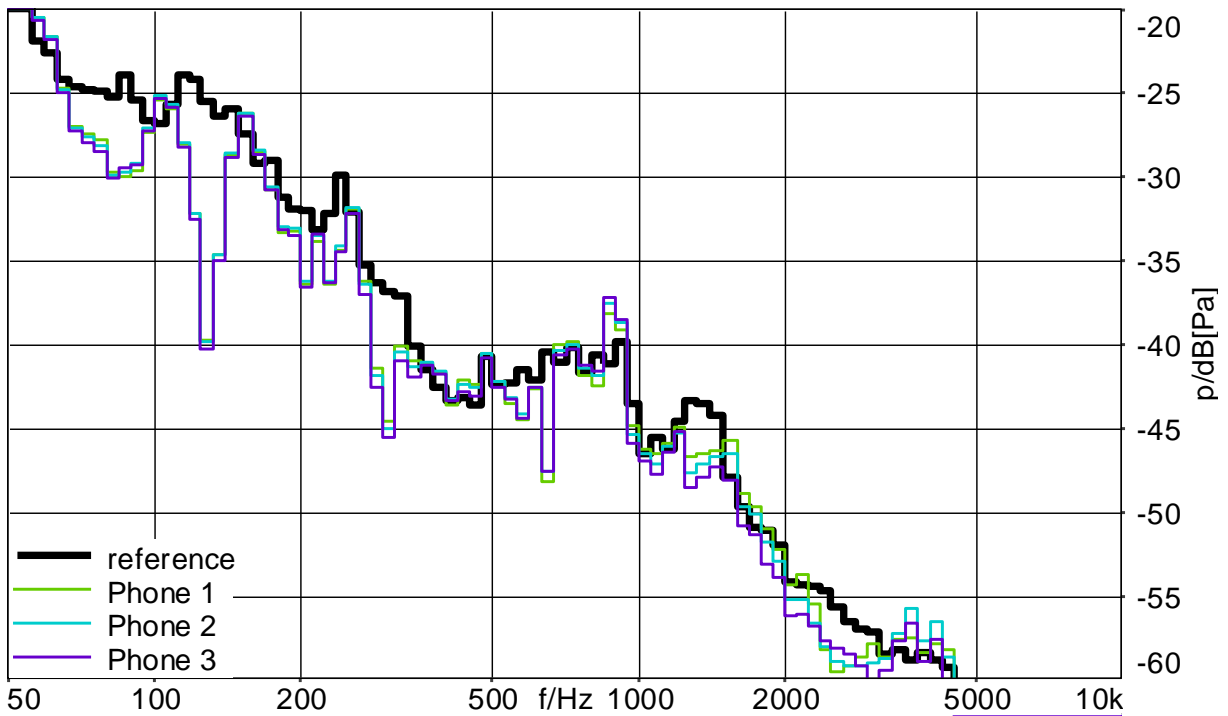

Figure 25: Averaged signal of mics 3,4,5 compared to the reference microphone spectrum recorded close to the terminal primary microphone position, HAE-BGN simulation method, Noise: inside car

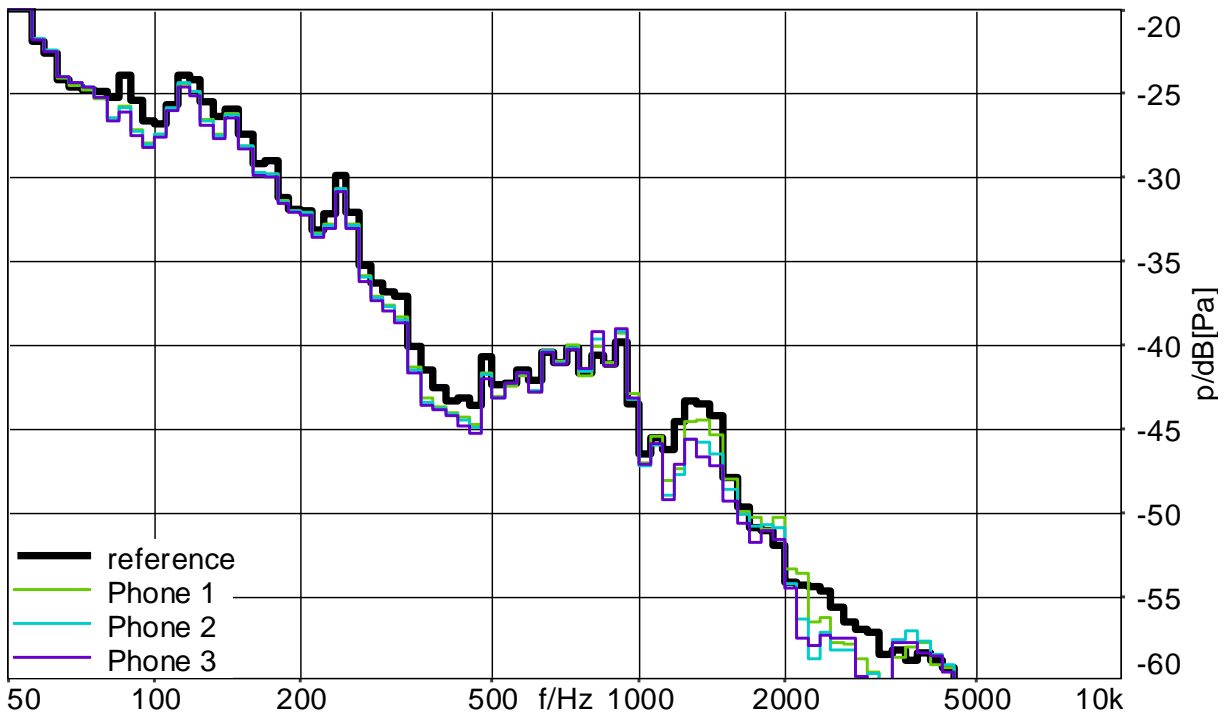

Figure 26: Averaged signal of mics 3,4,5 compared to the reference microphone spectrum recorded close to the terminal primary microphone position, 3PASS simulation method, Noise: inside car

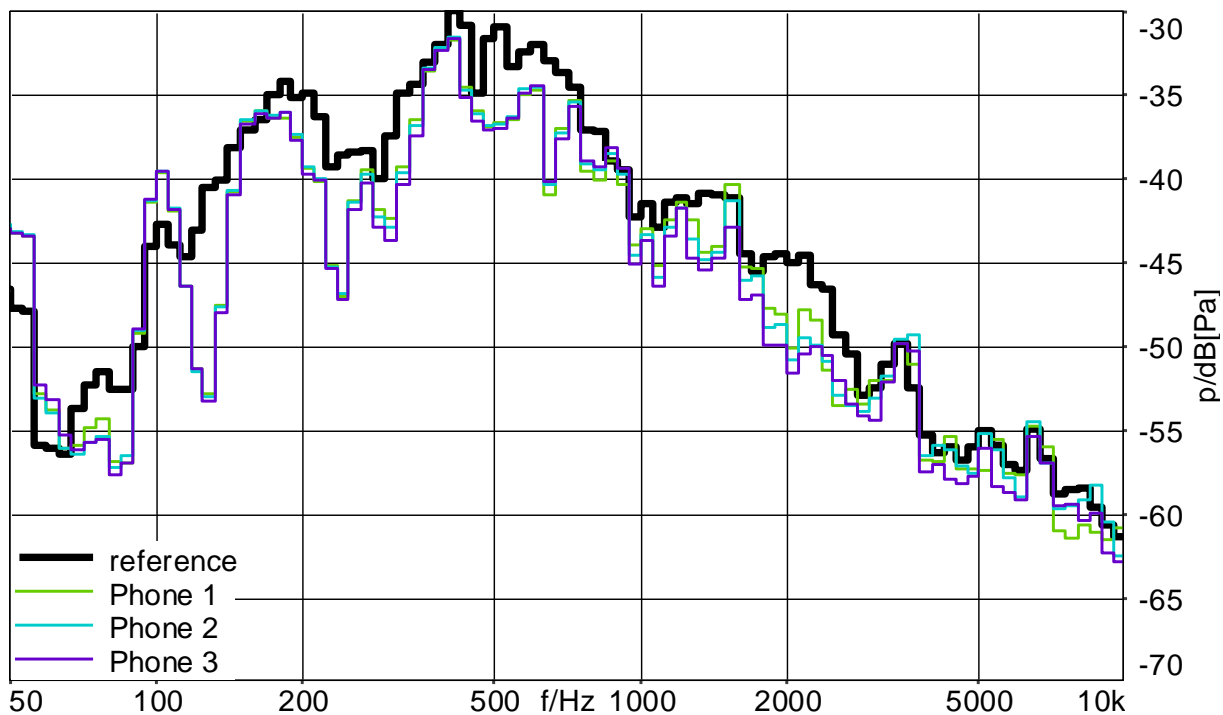

Figure 27: Averaged signal of mics 3,4,5 compared to the reference microphone spectrum recorded close to the terminal primary microphone position, HAE-BGN simulation method, Noise: cafeteria

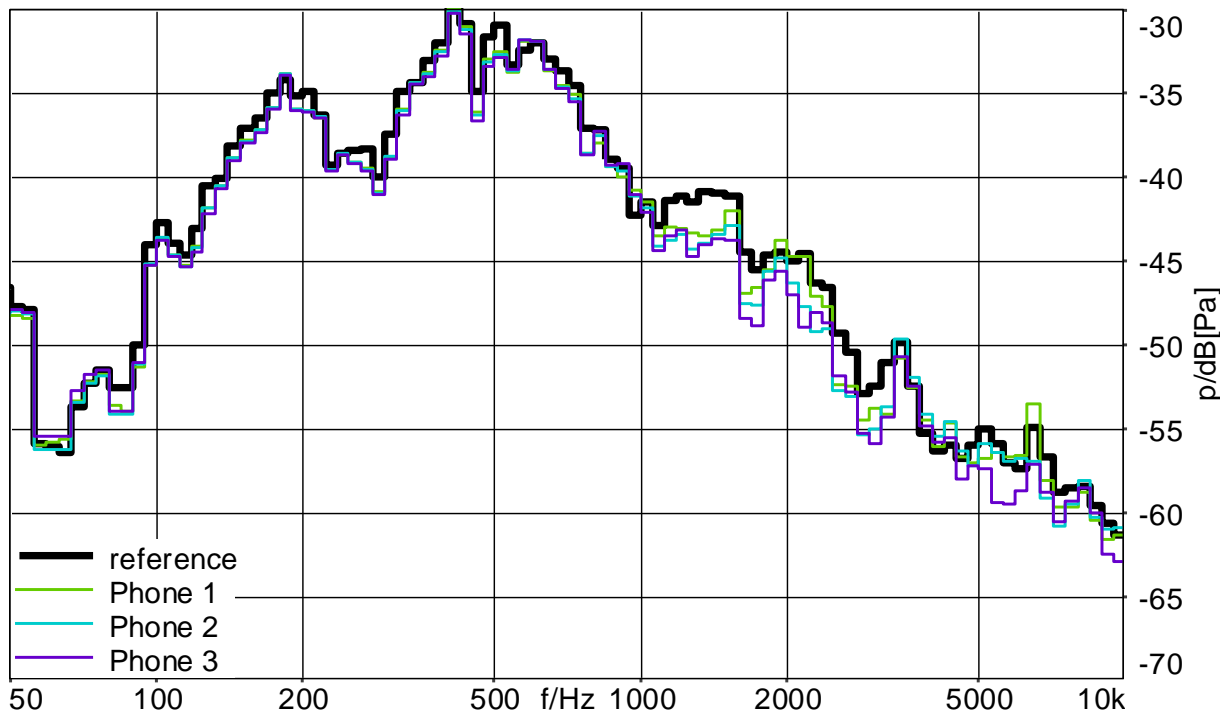

Figure 28: Averaged signal of mics 3,4,5 compared to the reference microphone spectrum recorded close to the terminal primary microphone position, 3PASS simulation method, Noise: cafeteria

2.6 Speech quality in background noise using 3QUEST according to ETSI TS 103 106

For the three mobile phones, tests were performed using the S-MOS, N-MOS and G-MOS prediction by means of 3QUEST [10] according to ETSI TS 103 106 [3]. The tests were conducted for both background noise simulations (3PASS according to TS 103 224 and HAE-BGN according to ES 103 396-1) and for a variety of positions.

The following positions were used:

	Description	Xe [mm]	Ye [mm]	Ze [mm]	A [°]	B [°]	C [°]	Ym [mm]
1	Default	0	0	0	0	0	0	0
2	Special up	0	0	0	-15	5	-1	0
3	Special down	0	0	0	18	10	2	0
4	Default up	0	0	0	-50	0	0	0
5	Default down	0	0	0	30	0	0	0
6	Default down and moved	0	-40	0	30	0	0	0
7	Out	-10	0	0	0	30	0	0

Table 4: Positions of mobile phones used in the test

The following results are presented here:

- Silence Condition
 - o Comparison of S-, N- and G-MOS values at different positions if no BGN is present.
- Average over all background noises
 - o The results of all background noises were averaged and plotted. The average S-, N- and GMOS is used e.g. in the 3GPP standards TS 26.1312 [4] and TS 26.132 [5]. In these results we see the average influence of the position on the MOS values.
- Comparison of individual MOS values
 - o The scatterplots allow a detailed comparison of the two background noise simulation methods and the impact of positioning when using different background noises.

2.6.1.1 Phone 1

2.6.1.1.1 Silence condition

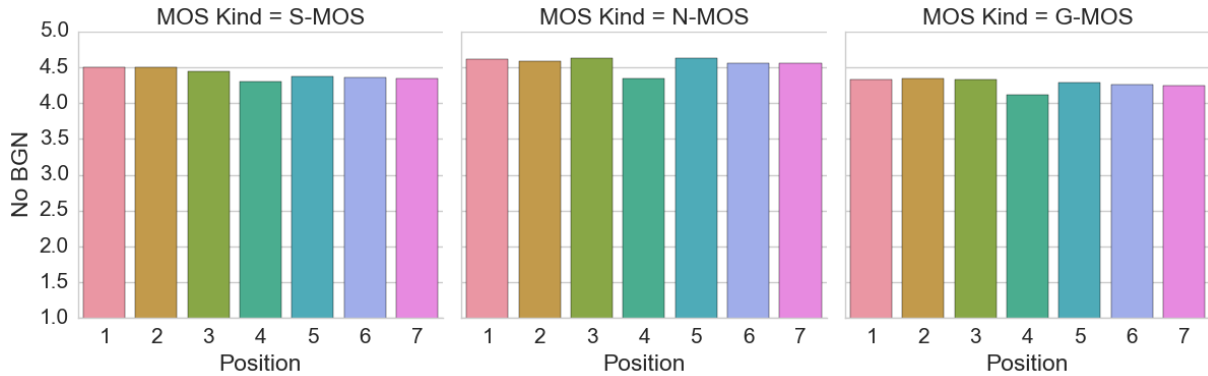

Figure 29: S-, N- and G-MOS results in silence

As it can be seen in Figure 29, only very little positioning dependant degradation of speech quality is observed for this phone in silence.

2.6.1.1.2 Average over background noises

2.6.1.1.2.1 Absolute averaged values

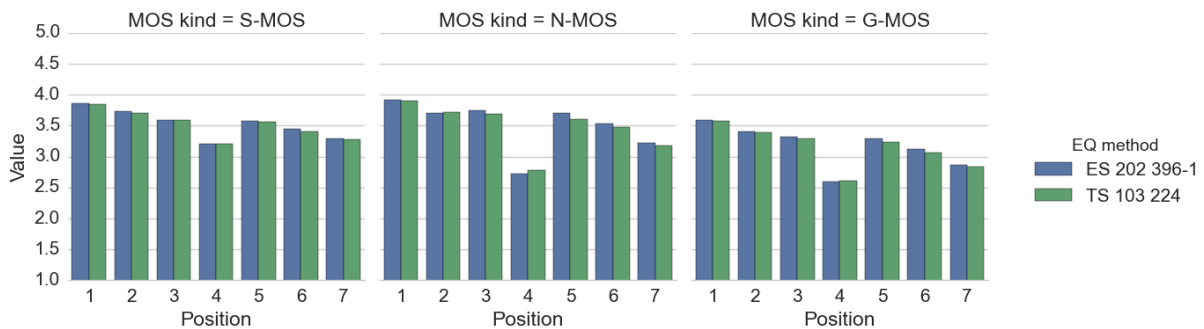

Figure 30: Averaged S-, N- and G-MOS results over all background noises

For this phone the averaged S- N- and G-MOS values depend quite on the position chosen (see Figure 30). The biggest impact can be seen on N-MOS; the position mostly affected is position 4 where N-MOS degrades by more than 1 MOS on average compared to the nominal position.

2.6.1.1.3 Avg(ES 202 396-1) - Avg(TS 103 224)

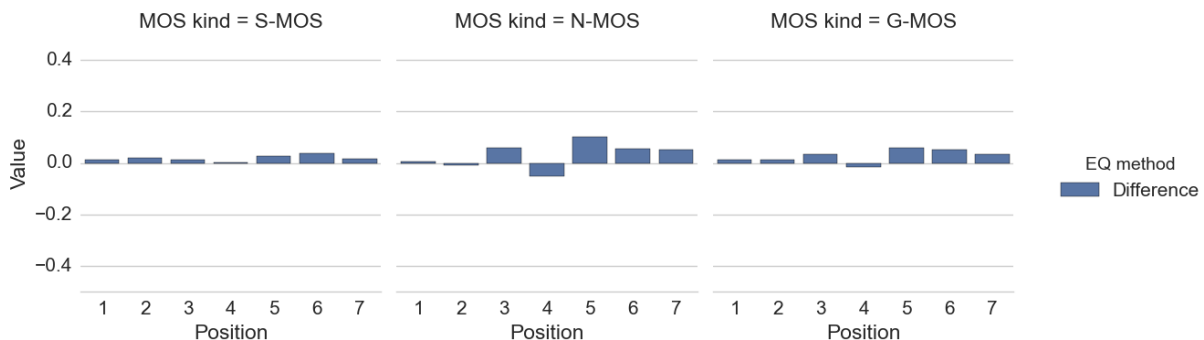

Figure 31: Differences in averaged S-, N- and G-MOS due to different background noise simulation techniques

Figure 31 shows the average difference between the two background noise simulation methods for phone 1. The average differences are small; the biggest impact can be seen for N-MOS at position 5.

As it can be seen in Figure 32 to Figure 37 the differences of the two background noise simulation methods are small for the individual noises as well.

2.6.1.1.4 Comparison of MOS values

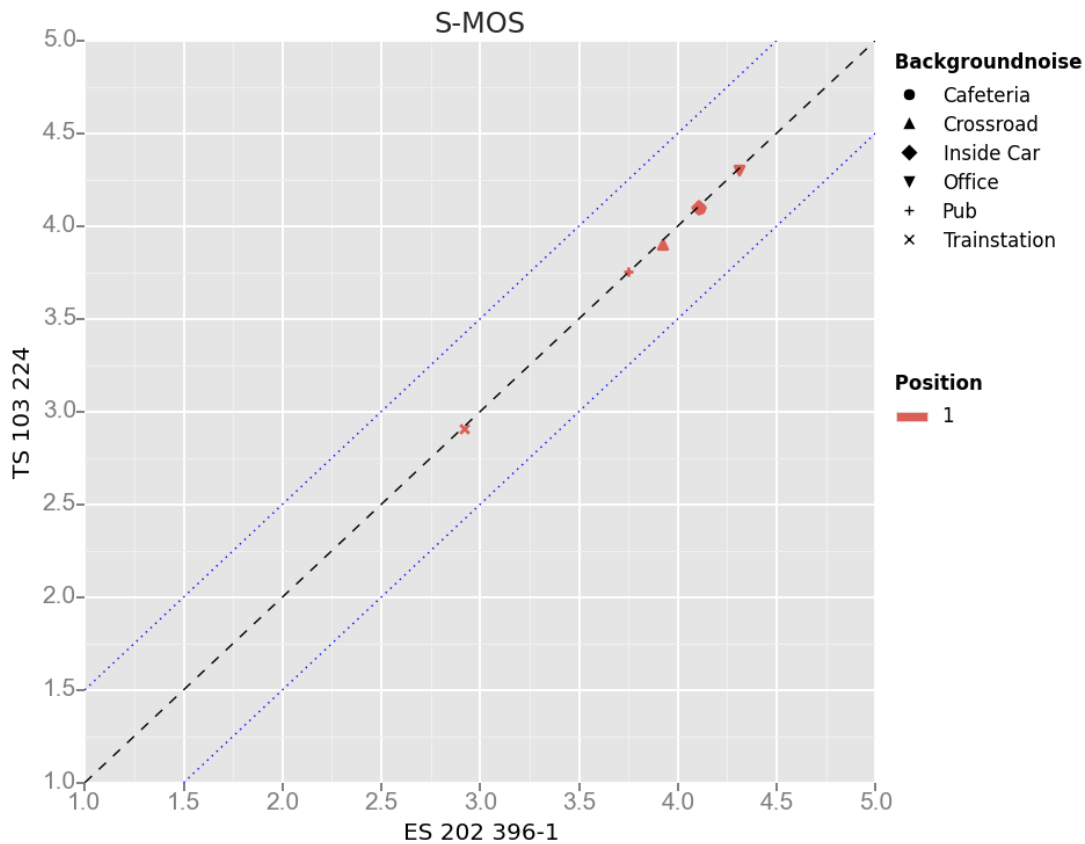

Figure 32: Comparison of individual S-MOS differences due to different background noise simulation

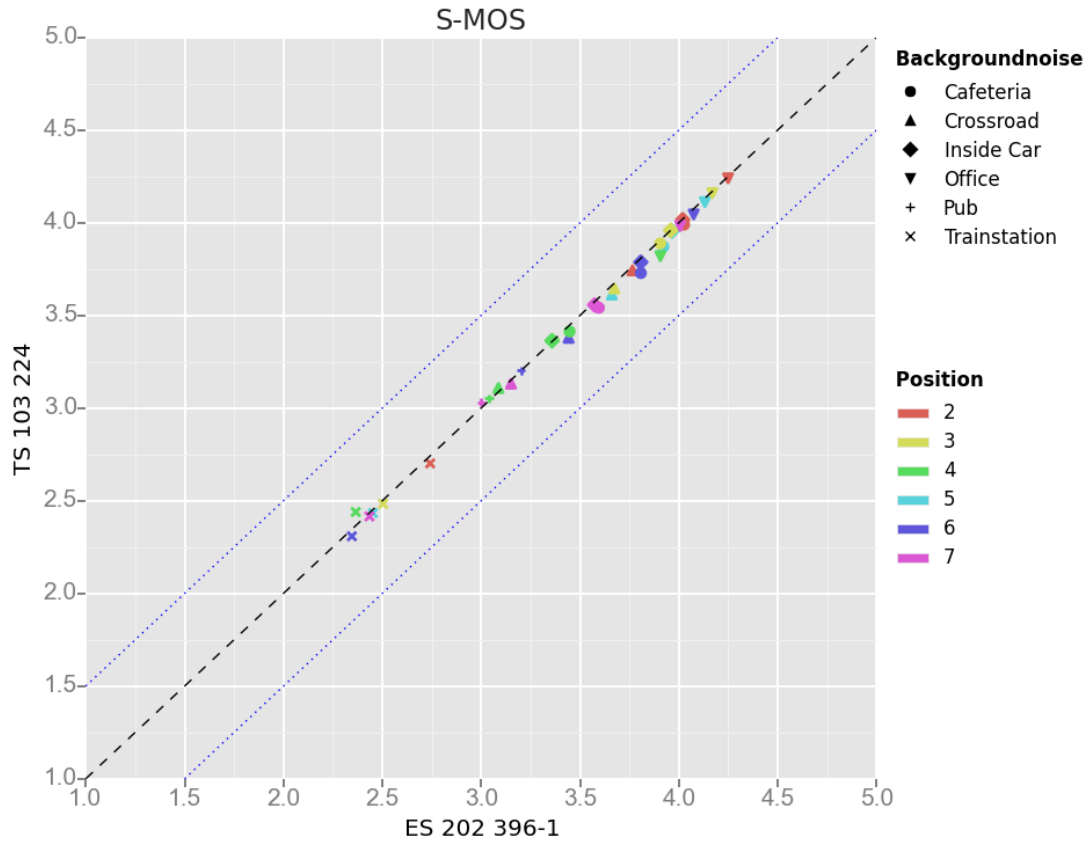

Figure 33: Comparison of individual S-MOS differences due to different background noise simulation

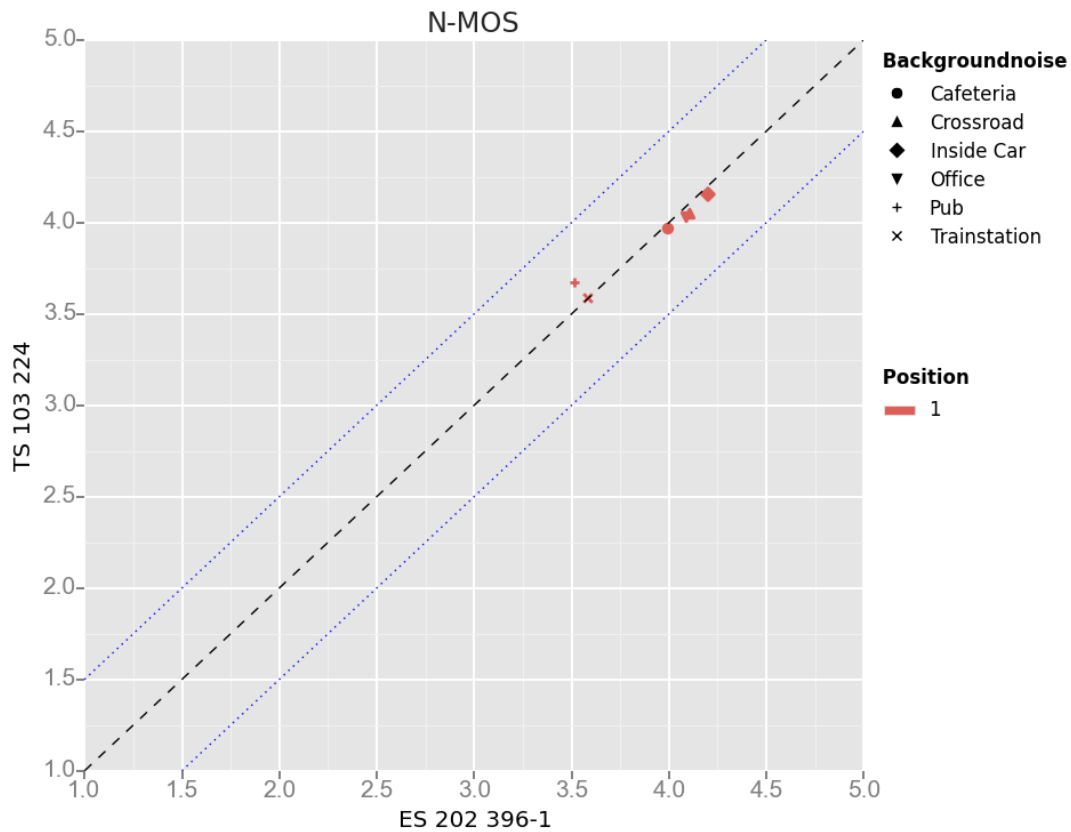

Figure 34: Comparison of individual N-MOS differences due to different background noise simulation

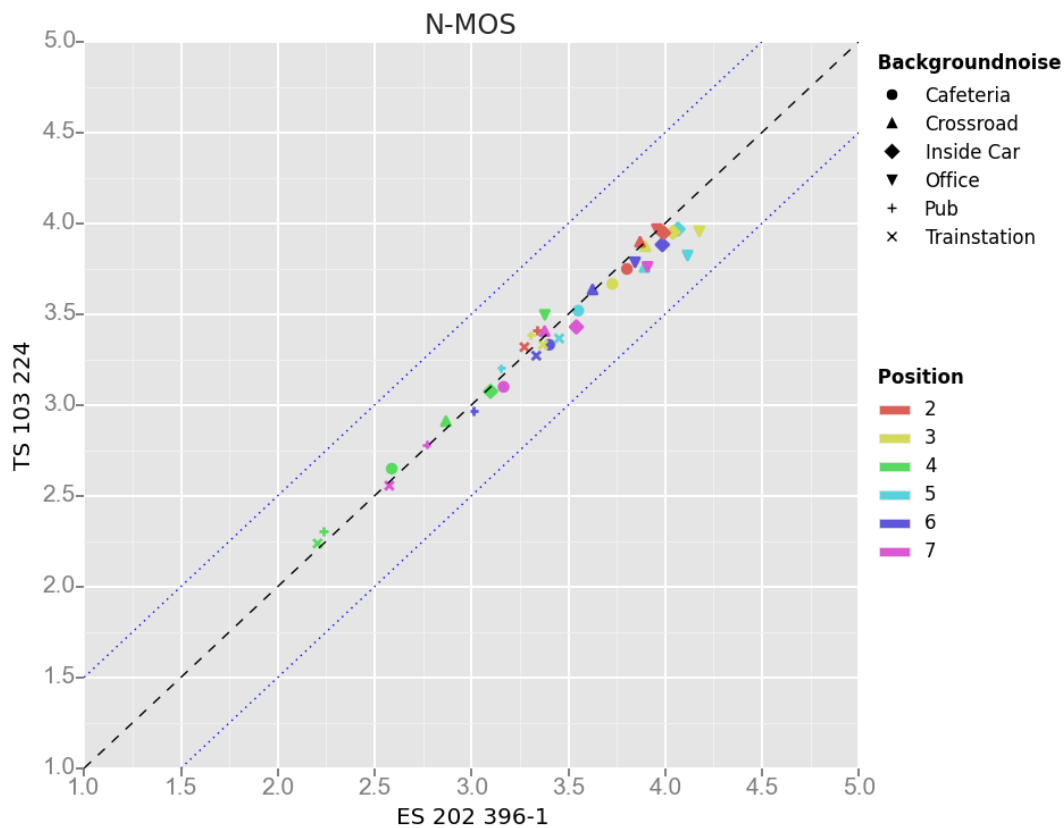

Figure 35: Comparison of individual N-MOS differences due to different background noise simulation

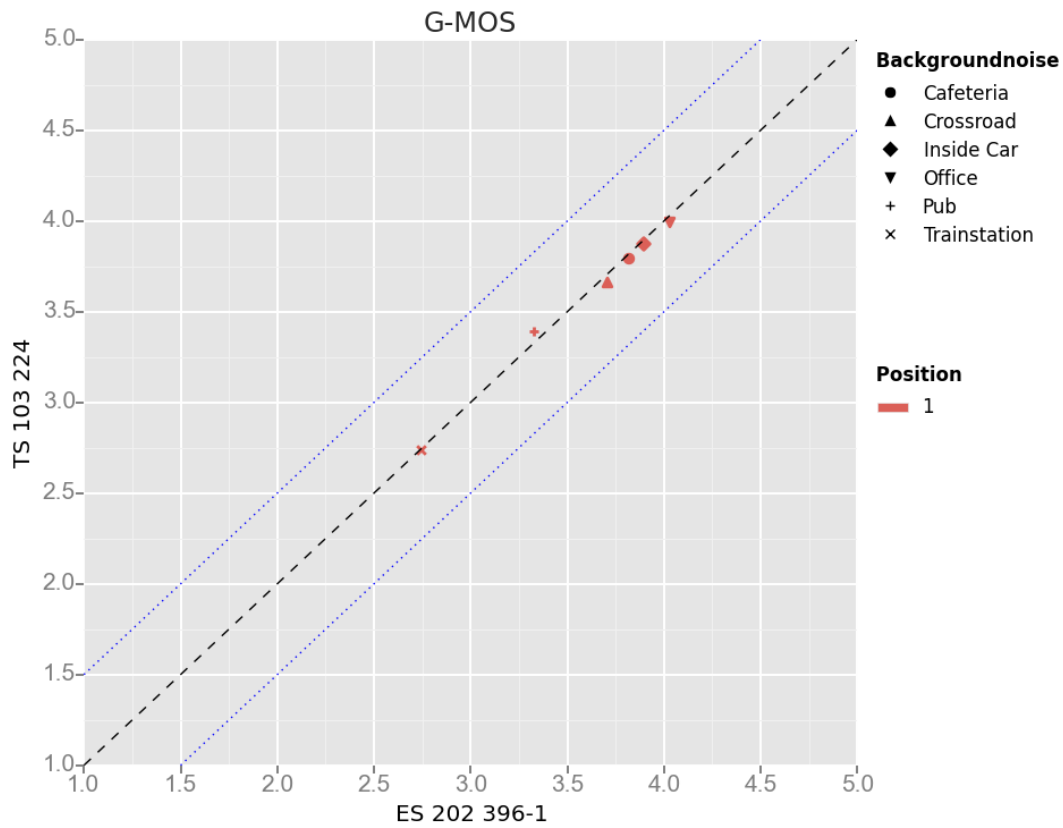

Figure 36: Comparison of individual G-MOS differences due to different background noise simulation

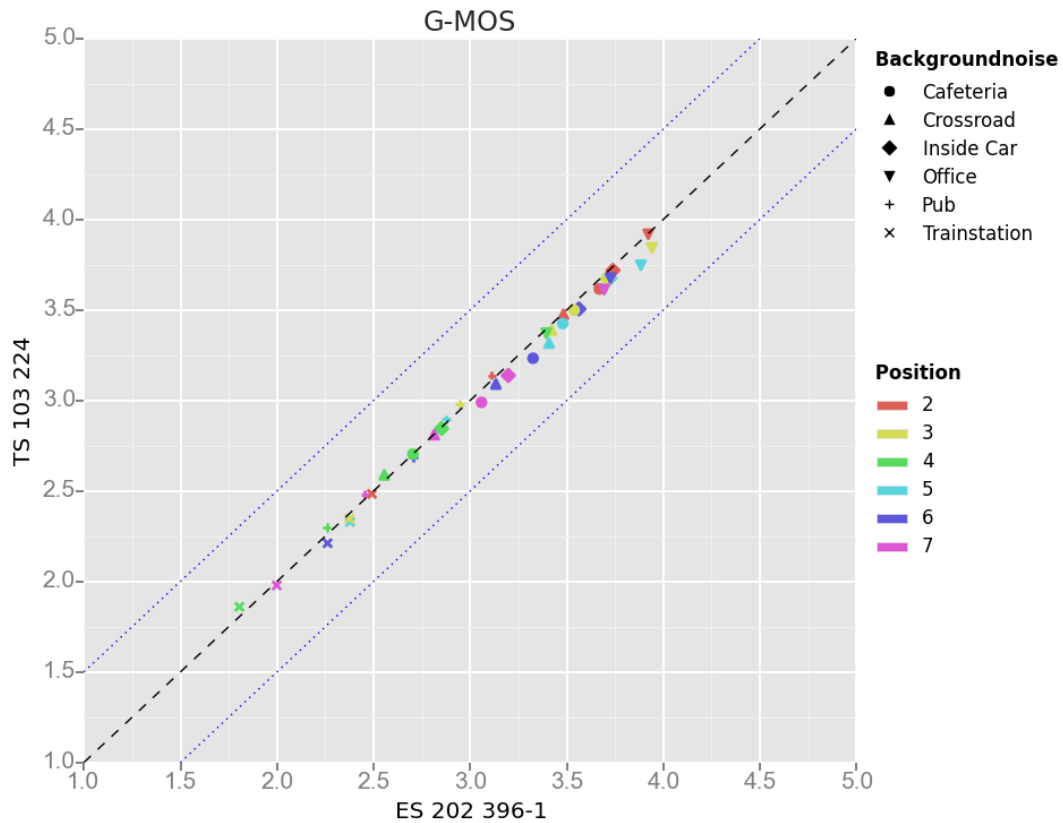

Figure 37: Comparison of individual G-MOS differences due to different background noise simulation

2.6.1.2 Phone 2

2.6.1.2.1 Silence condition

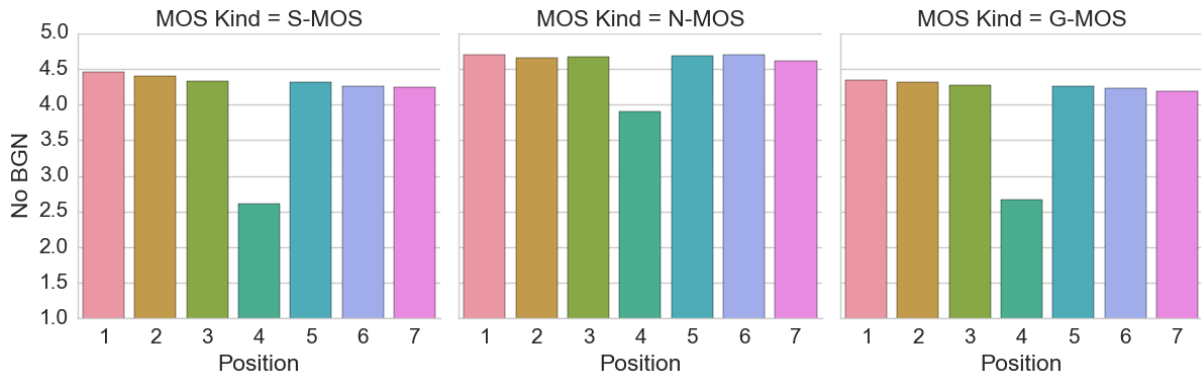

Figure 38: S-, N- and G-MOS results in silence

As it can be seen in Figure 38, only little positioning dependent degradation of speech quality is observed for this phone in silence except for position 4. In position 4 mainly the S-MOS decreases significantly leading to a poor G-MOS as well.

2.6.1.2.2 Average over background noises

2.6.1.2.2.1 Absolute averaged values

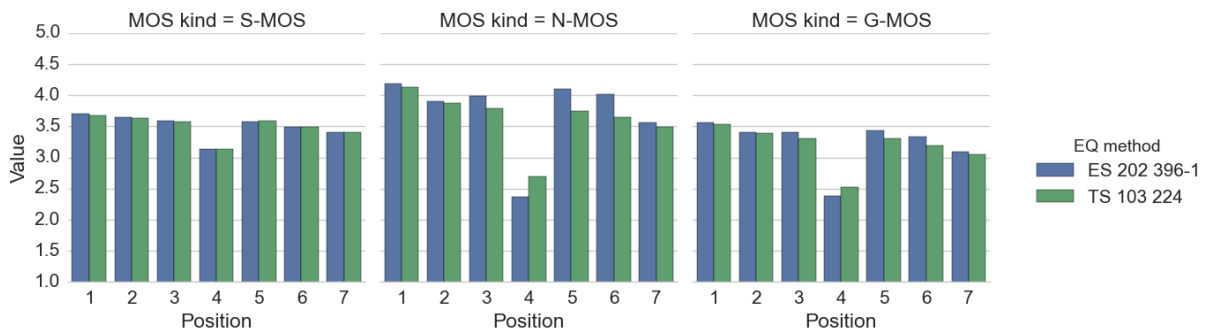

Figure 39: Averaged S-, N- and G-MOS results over all background noises

For this phone the averaged S- N- and G-MOS values depend not so much on the position chosen as phone 1 (see Figure 39). The biggest impact can be seen on N-MOS; the position mostly affected is position 4 where N-MOS degrades by more than 1 MOS on average compared to the nominal position, whereas for the other positions the decrease in quality is in the range of 0.5 MOS.

2.6.1.2.3 Avg(ES 202 396-1) - Avg(TS 103 224)

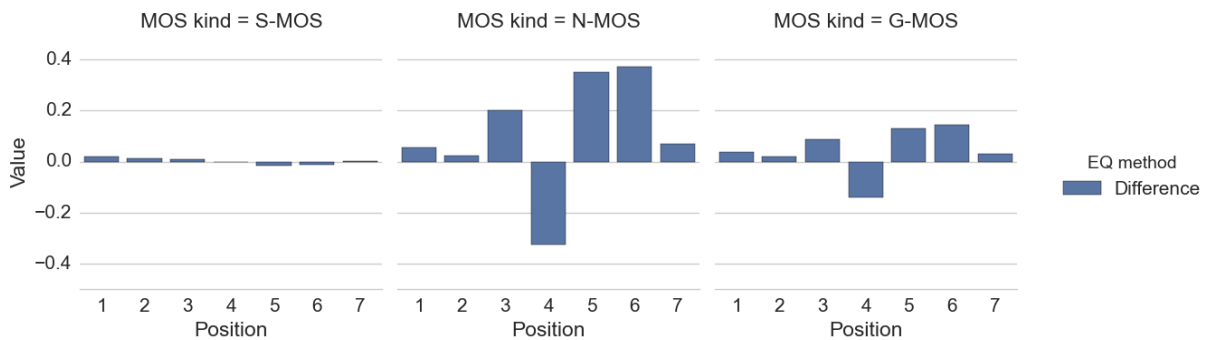

Figure 40: Differences in averaged S-, N- and G-MOS due to different background noise simulation techniques

Figure 40 shows the average difference between the two background noise simulation methods for phone 2. In contrast to phone 1 the simulation method chosen may lead to quite different results, especially in N-MOS and G-MOS. The difference observed is position-dependent and may be up to 0.4 MOS. The biggest impact can be seen for N-MOS at positions 3, 4, 5 and 6. The deviations may be positive and negative.

A similar observation can be made when evaluating the differences in the individual noises as shown Figure 41 to Figure 46. Mainly for N-MOS the differences measured when using the two background noise simulation methods may be quite big even in the default position. The maximum individual difference observed is about 1 MOS.

2.6.1.2.4 Comparison of MOS values

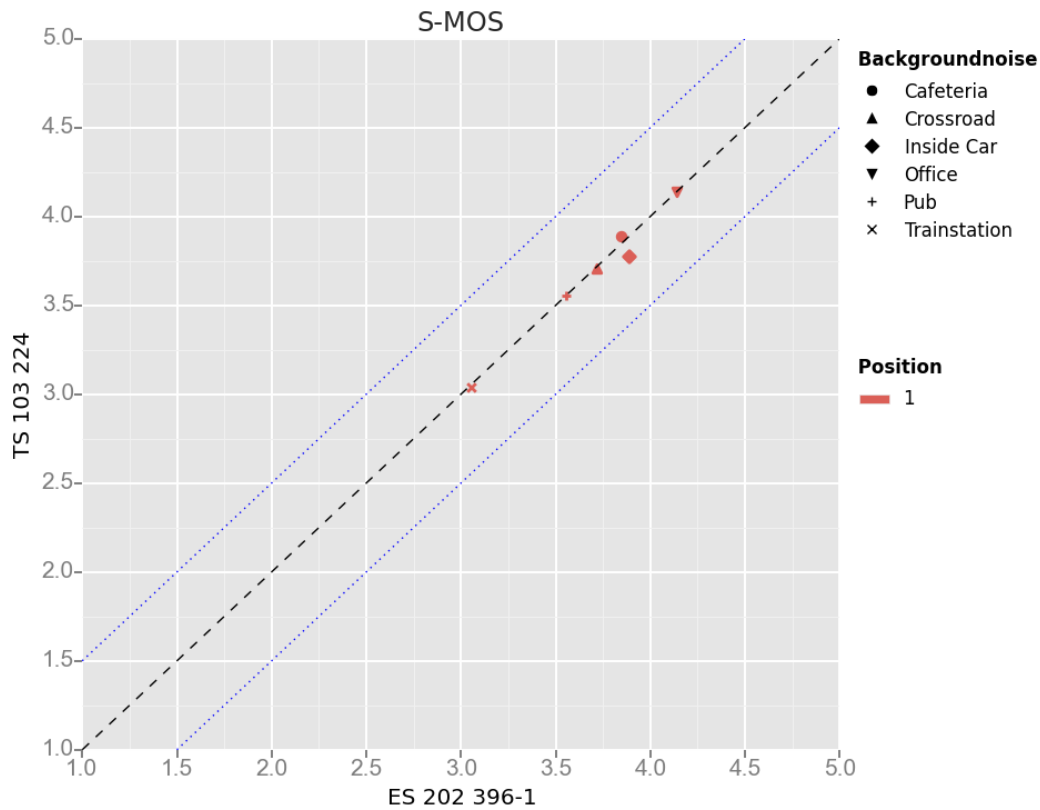

Figure 41: Comparison of individual S-MOS differences due to different background noise simulation

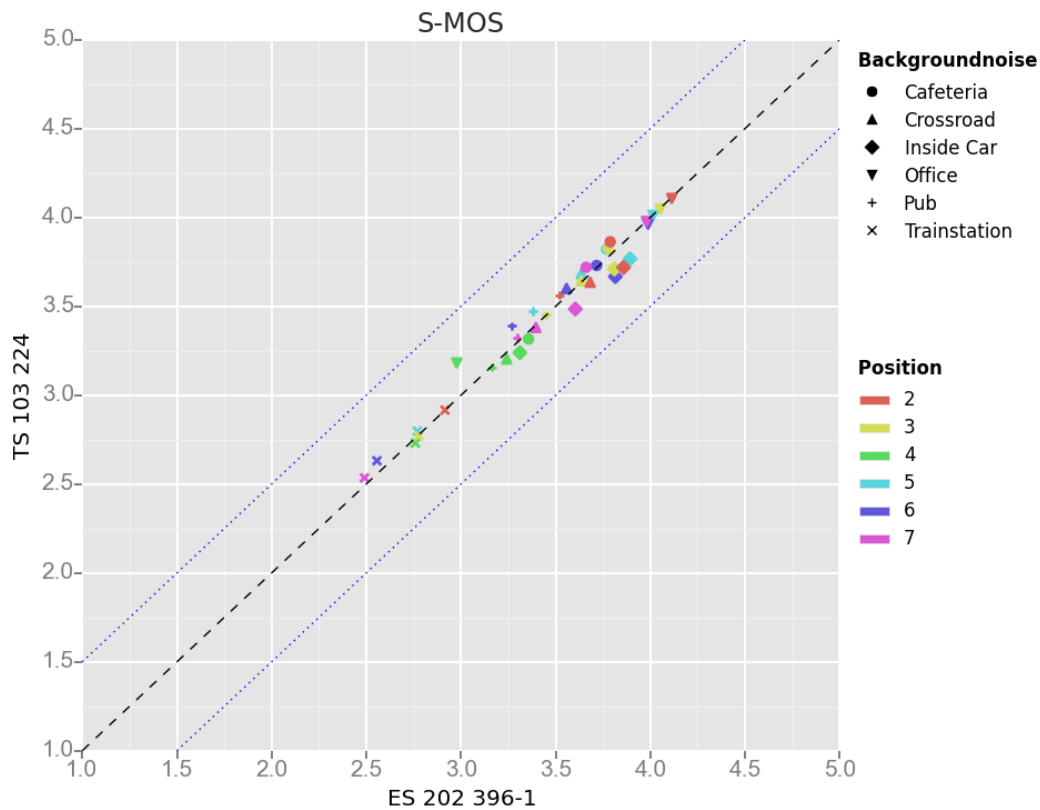

Figure 42: Comparison of individual S-MOS differences due to different background noise simulation

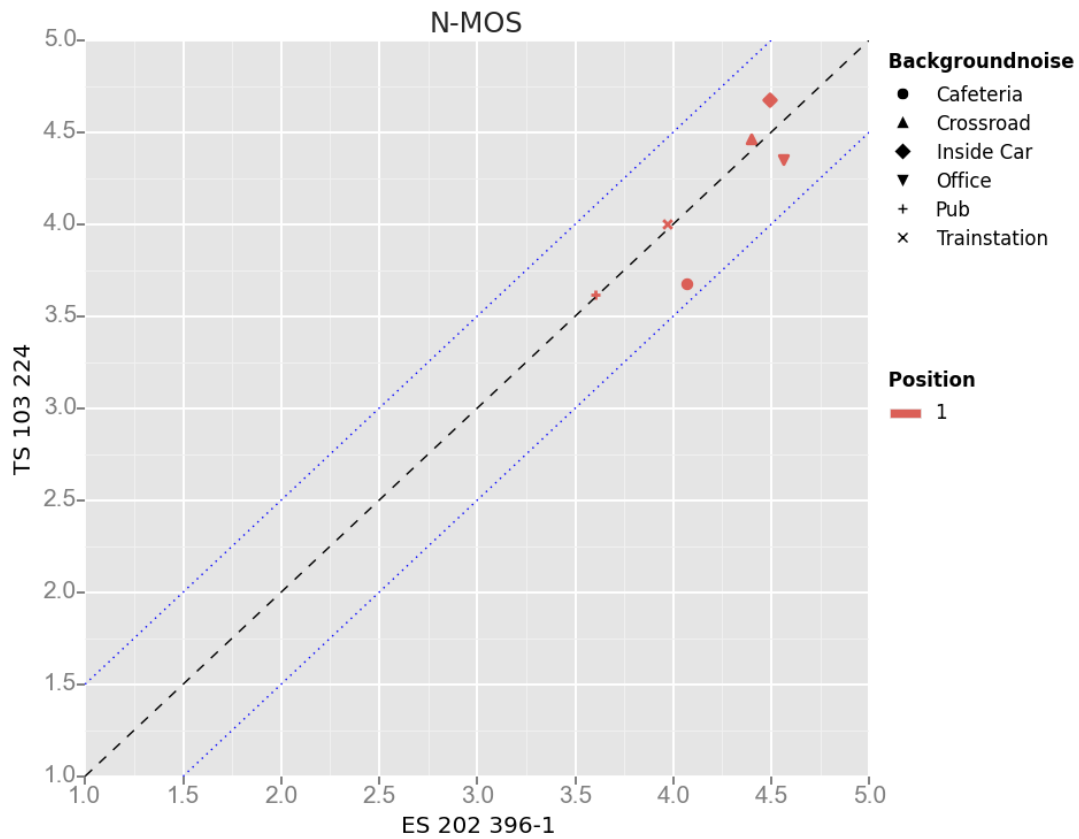

Figure 43: Comparison of individual N-MOS differences due to different background noise simulation

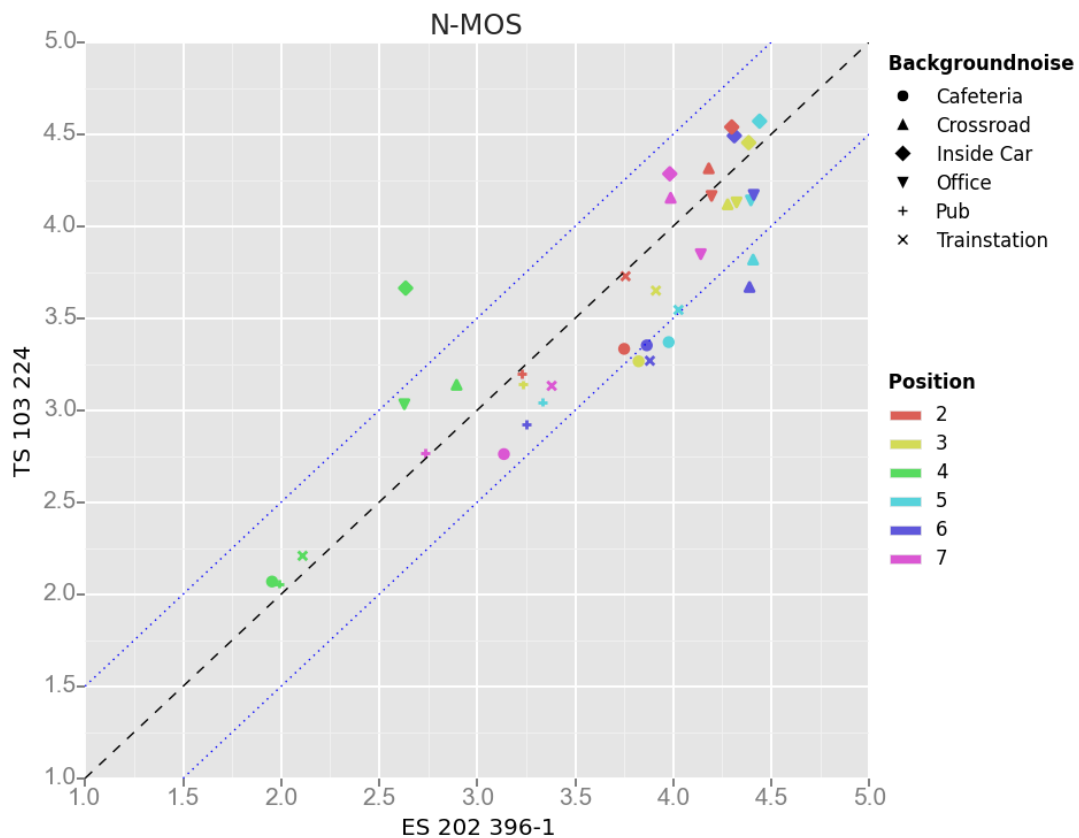

Figure 44: Comparison of individual N-MOS differences due to different background noise simulation

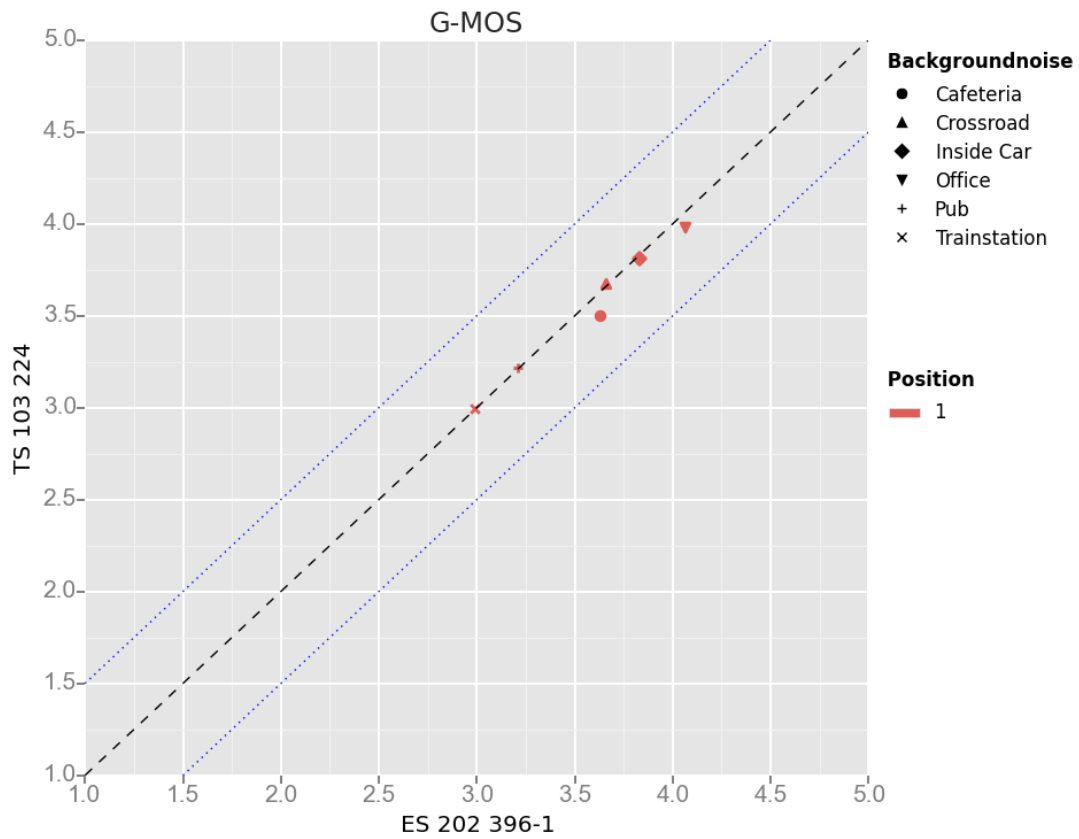

Figure 45: Comparison of individual G-MOS differences due to different background noise simulation

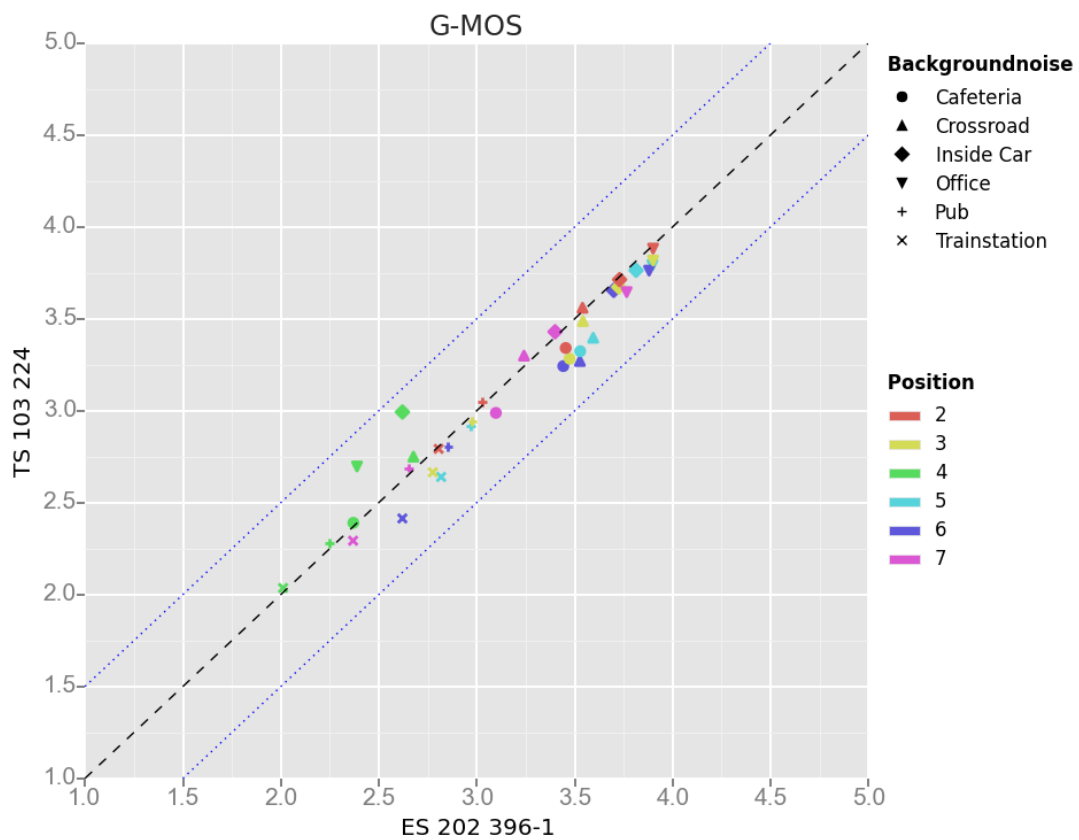

Figure 46: Comparison of individual G-MOS differences due to different background noise simulation

2.6.1.3 Phone 3

For phone 3 the experimental setup was slightly changed in order to simulate a low volume talker. For this purpose the speech level was set to -7.7 dBPa.

2.6.1.3.1 Silence condition

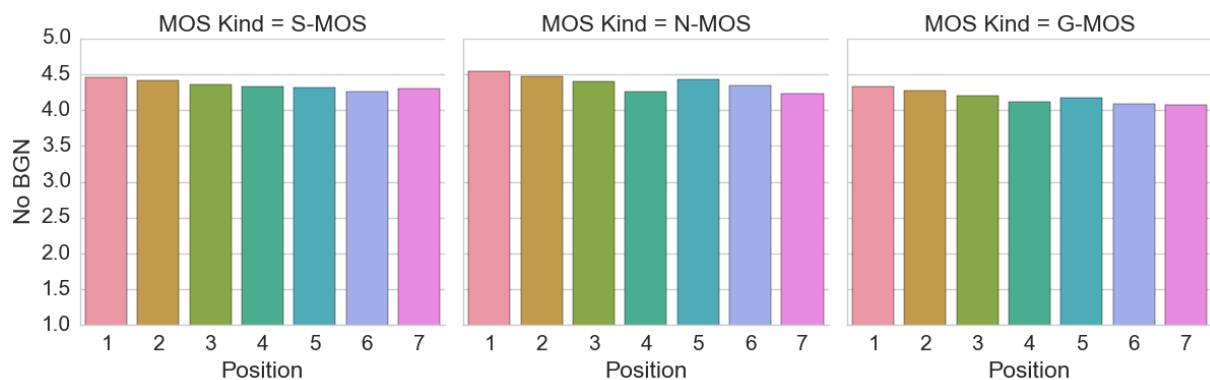

Figure 47: S-, N- and G-MOS results in silence

As it can be seen in Figure 47, only little positioning dependant degradation of speech quality is observed for this phone in silence.

2.6.1.3.2 Average over background noises

2.6.1.3.2.1 Absolute averaged values

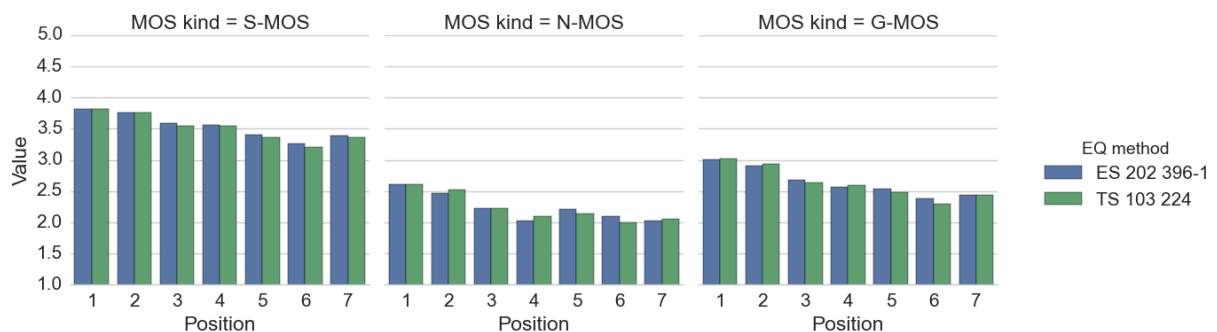

Figure 48: Averaged S-, N- and G-MOS results over all background noises

For this phone the averaged S- N- and G-MOS values depend on the position chosen (see Figure 48). The impact can be seen for S-MOS, N-MOS and G-MOS; the decrease in quality is in the range of 0.5 MOS. It can be seen clearly that this phone mainly tries to preserve the speech quality when applying lower speech levels resulting in lower N-MOS values rather than keeping N-MOS values high.

2.6.1.3.3 Avg(ES 202 396-1) - Avg(TS 103 224)

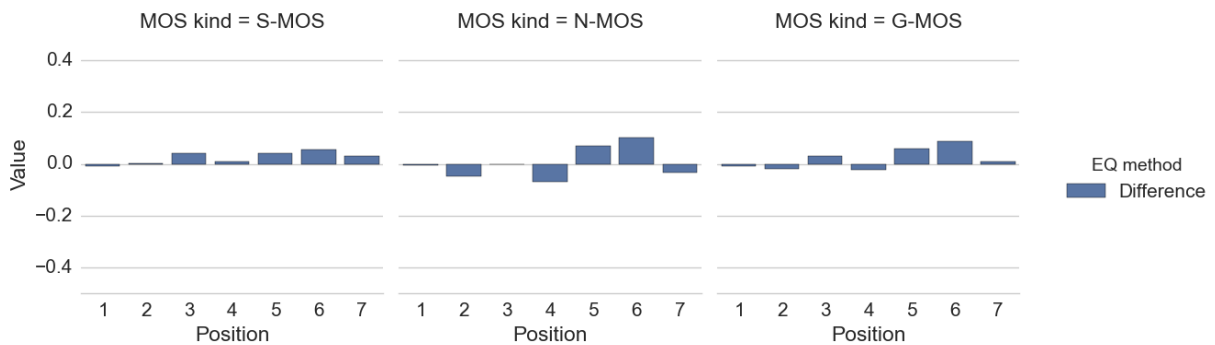

Figure 49: Differences in averaged S-, N- and G-MOS due to different background noise simulation techniques

Figure 49 shows the average difference between the two background noise simulation methods for phone 3. Similar to phone 1 the simulation method chosen leads to small differences in the results. The difference observed is position-dependent and may be in the range of 0.1 MOS.

A different observation can be made when evaluating the differences in the individual noises as shown in Figure 50 to Figure 55. Mainly for N-MOS the differences measured when using the two background noise simulation methods may be big even in the default position. The maximum individual difference observed is about 0.5 MOS.

2.6.1.3.4 Comparison of MOS values

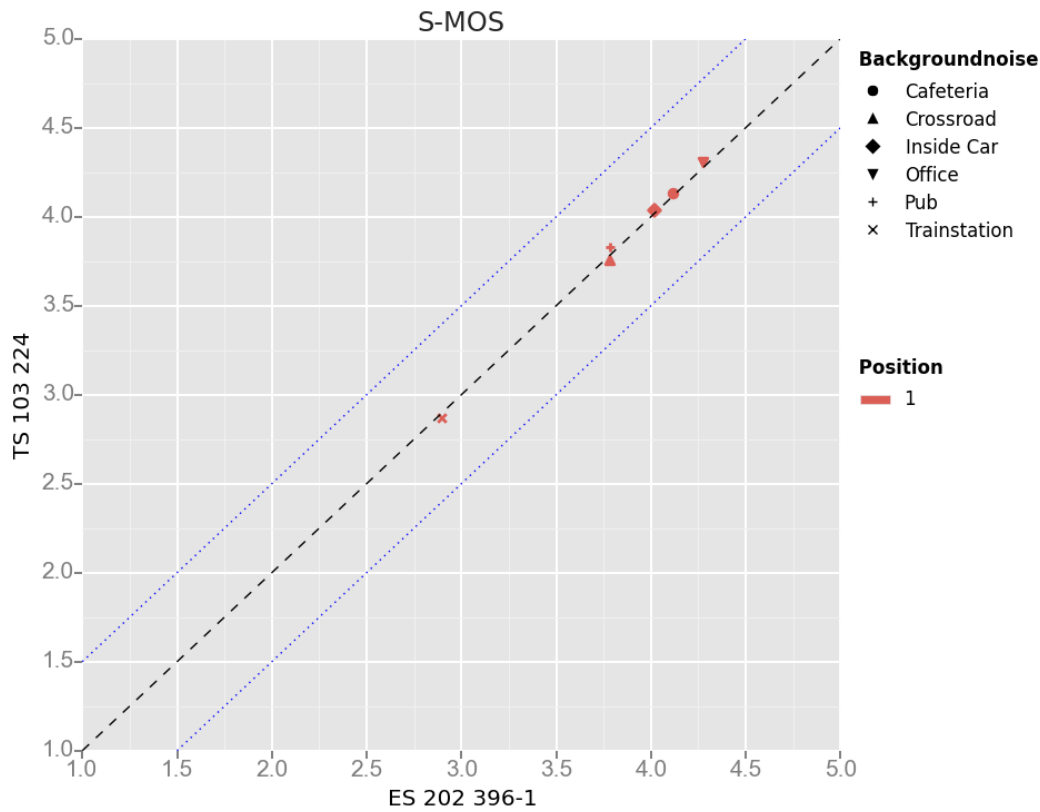

Figure 50: Comparison of individual S-MOS differences due to different background noise simulation

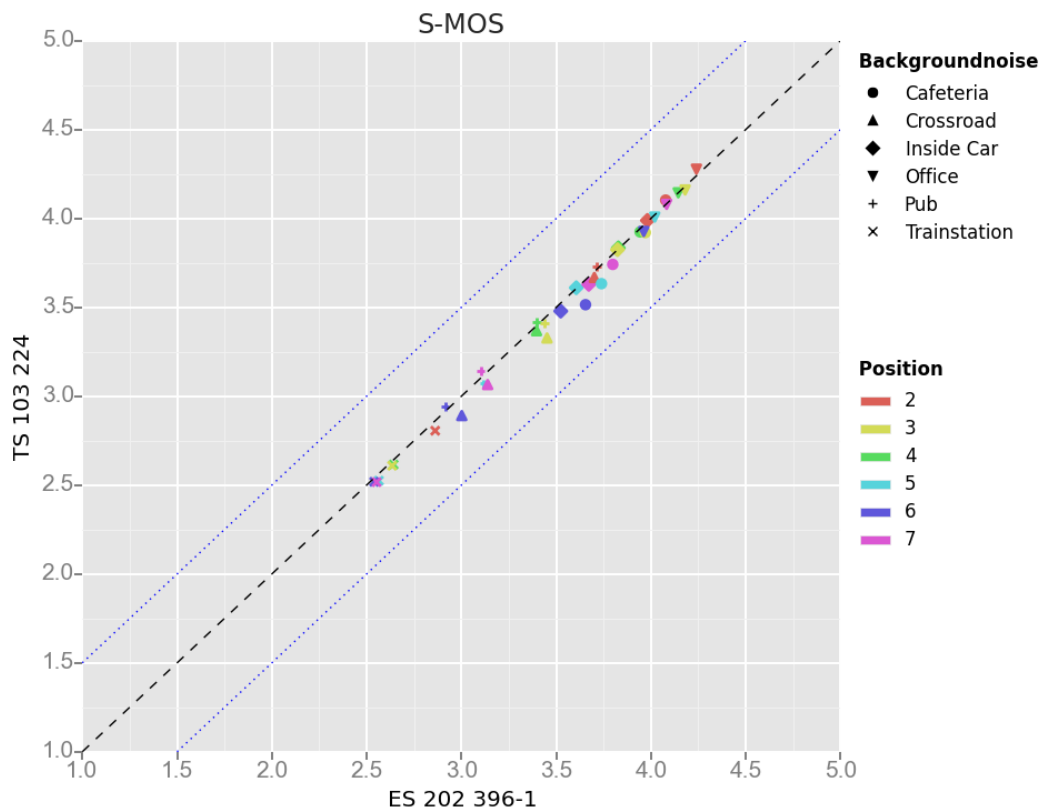

Figure 51: Comparison of individual S-MOS differences due to different background noise simulation

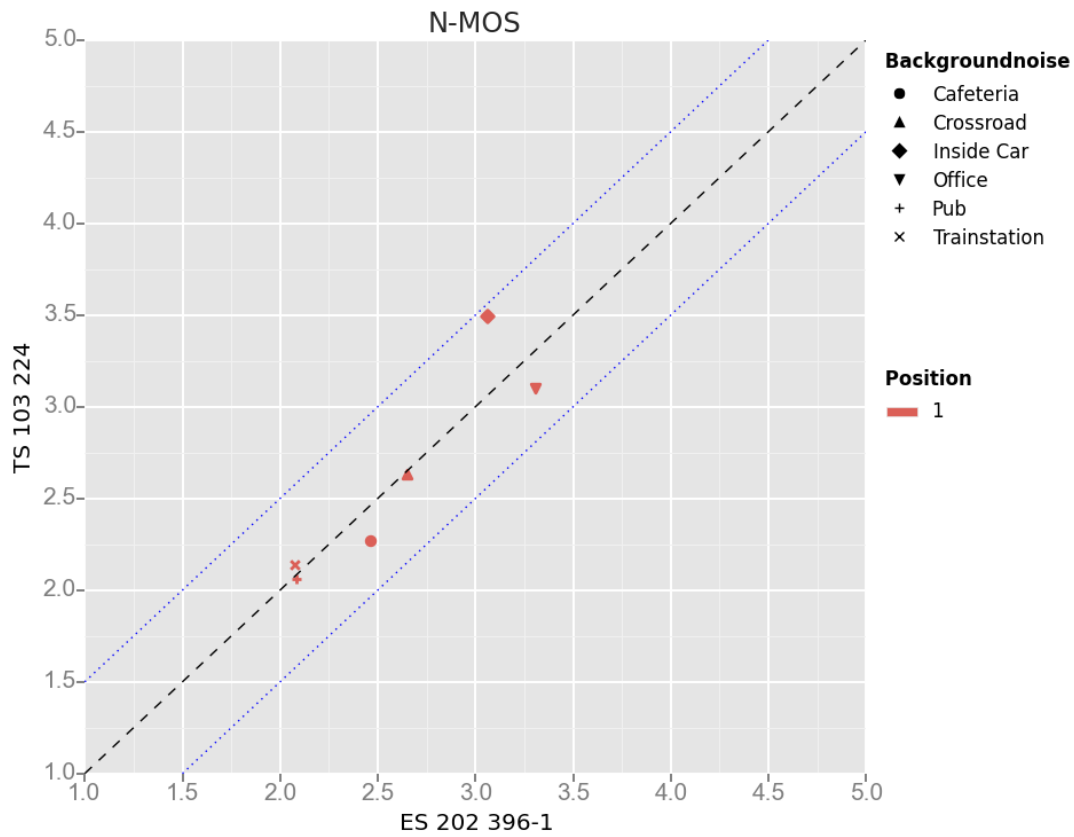

Figure 52: Comparison of individual N-MOS differences due to different background noise simulation

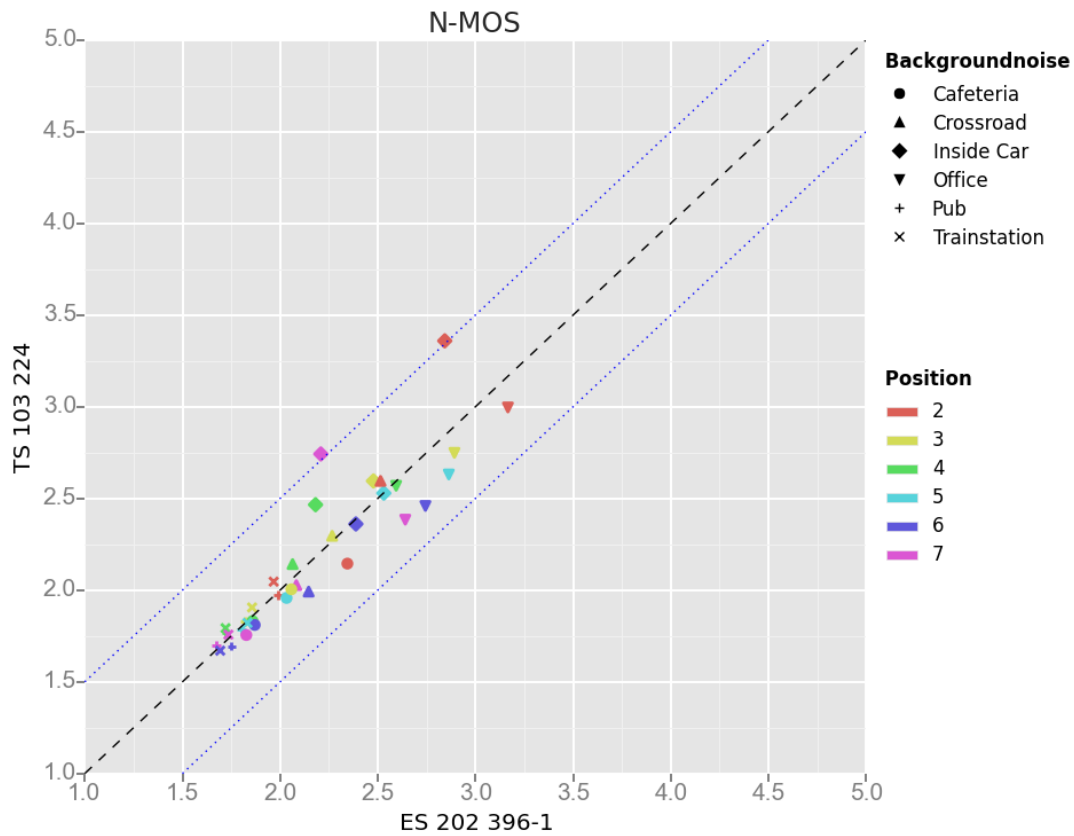

Figure 53: Comparison of individual N-MOS differences due to different background noise simulation

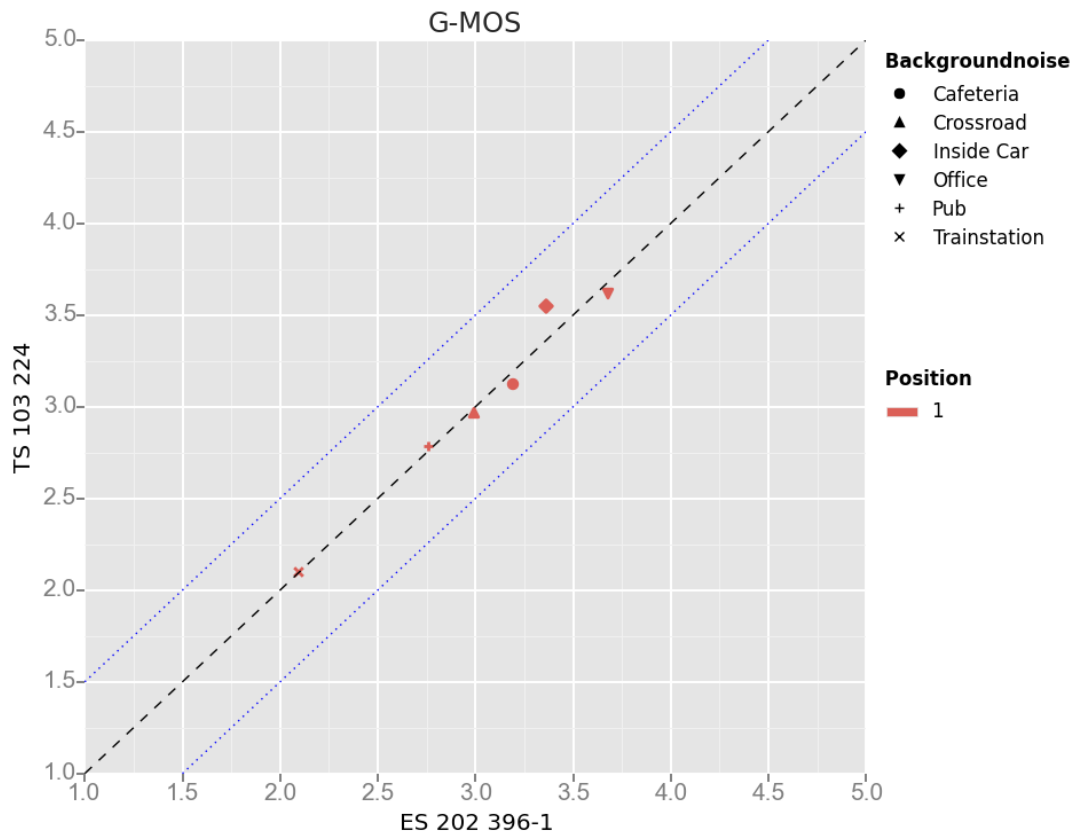

Figure 54: Comparison of individual G-MOS differences due to different background noise simulation

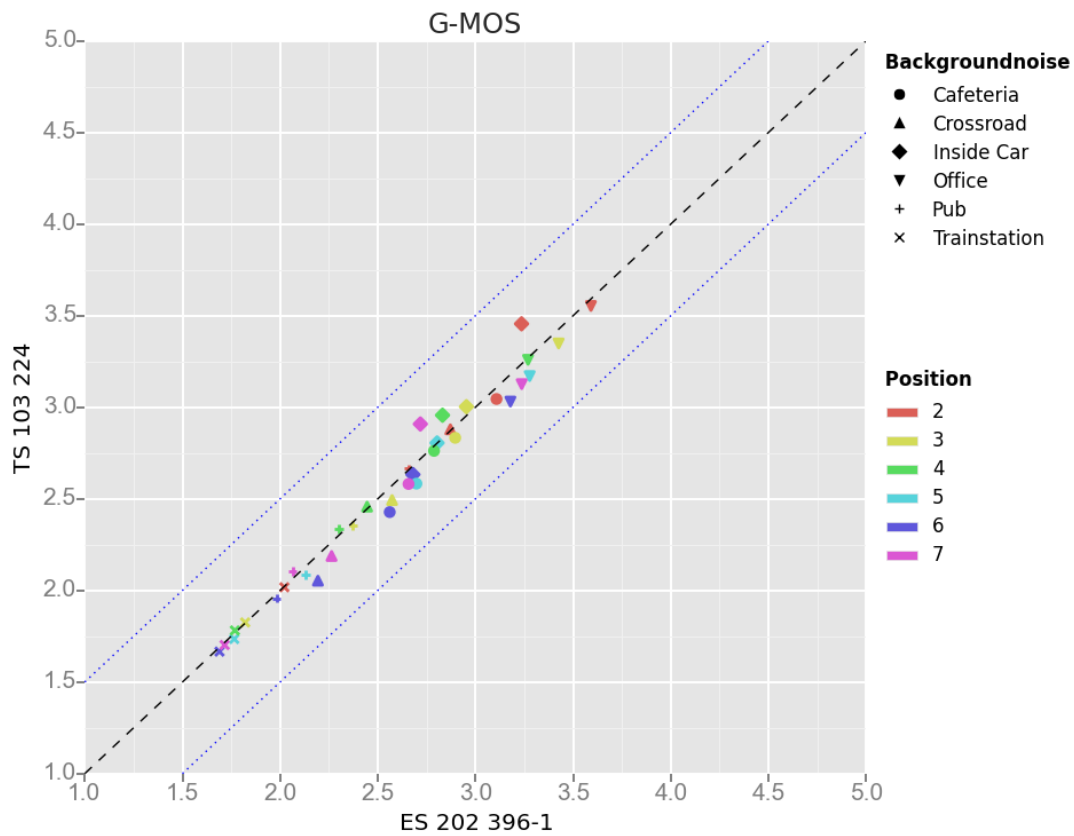

Figure 55: Comparison of individual G-MOS differences due to different background noise simulation

2.7 Conclusions of the mobile phone experiment

The study clearly shows the superior performance of the 3PASS (ETSI TS 103 224) 8-channel background noise simulation method compared to HAE-BGN, the 4.1 method based on binaural recordings as standardized in ES 202 396-1. The sound field characteristics is preserved more accurately not only for the standard positions but for the typical area of positional robustness testing around HATS as well.

Depending on the signal processing used in the phones, significant differences in S- N- and G-MOS calculations using 3QUEST according TS 103 106 can be seen in combination with the two different sound field simulation techniques for both the tests in the standard position as well as for positional robustness tests. It can be assumed that in the case of phones using more sophisticated signal processing for background noise cancellation, the more accurate 3PASS background noise simulation method leads to much more realistic performance measurements. Furthermore, advanced methods will show their superior performance only if the more realistic simulation method is applied.

Based on these findings HEAD acoustics recommends the use of 3PASS for new developments and pursues the integration of ETSI TS 103 224 background noise simulation method as the preferred method in the different terminal related standards in 3GPP, ETSI, ITU-T and others.

3 Part 2: Speech Quality Measurements in Background Noise Using Different Sound Field Reproduction Techniques and Hands-Free Terminals

The investigations in the experiments described in this chapter are targeted to

- The evaluation of the sound-field reproduction accuracy of the two simulation methods 3PASS and HAE-BGN when used for hands-free and hand-held hands-free terminals.
- The reproduction accuracy between rooms and labs when using the two different reproduction methods.

3.1 Test setup

The tests were conducted at the HEAD acoustics premises in Aachen as part of the round robin test conducted in 3GPP in 2015. The participating labs were:

- Audience Inc.
- HEAD acoustics GmbH
- Orange
- Sony Mobile Communications

The results of the complete Round Robin test can be found in [11].

Six state of the art phones were used in our experiment. The general description of the phones used is shown in Table 1.

Name	Size
DUT1	138.1 x 67 x 6.9 mm
DUT2	143.4 x 70.5 x 6.8 mm
DUT3	138.5 x 70.9 x 8.9 mm
DUT4	162.8 x 85.4 x 8.7 mm
DUT5	127.3 x 64.9 x 8.6 mm
DUT6	150.1 x 72.7 x 9.6 mm

Table 5: Dimensions of mobile terminals used in the experiment

The setup for the 3PASS 8 ch. sound-field simulation technique is described in detail in TS 103 224 [2] and in the 3PASS manual [8]. The equalization procedure is completely automated, no manual post-equalization is required. When using the HAE-BGN 4.1 sound-field simulation technique as described in ETSI ES 202 396-1 [1] a manual post equalization is required as described in [1] and in the HAE-BGN manual [9]. For both simulation techniques specific room requirements have to be respected as described in the ETSI standards.

In our experiment the following rooms were used:

Room number	C80	RT60	Length	Width	Height
Lab 1.1	37.1 dB	125 ms	3.3 m	2.4 m	2.03 m
Lab 1.2	20.5 dB	240 ms	3 m	5.18 m	2.85 m

Speaker height in Room 1:

Speakers 1-4 (Nubert nuLine 24): top edge 152 cm, lower edge 126 cm.

Speakers 5-8 (Nubert WS-203): top edge 137 cm, lower edge 99 cm.

Speaker height in Room 2:

Speakers 1-4 (Nubert nuBox381): top edge 150 cm, lower edge 112 cm.

Speakers 5-8 (Nubert nuBox381): top edge 104 cm, lower edge 66 cm.

Absorbing materials were introduced in room 2 to achieve the $C80 > 20\text{dB}$ as required by TS 103 224 [2].

As for the handset experiment the two different background noise methods were used:

- 3PASS - 8-speaker method (ETSI TS 103 224, [2]) using background noise from the ETSI TS 103 224 background noise database.
- HAE-BGN - 4.1 loudspeaker method (ETSI ES 202 396-1, [1]) **using the same noise scenarios as in TS 103 224** (binaurally recorded background noises in chapter 8.2 of EG 202 396-1 (noises equivalent to TS 103 224)), for handset DUT position. These background noises can be found in the ETSI ES 202 396-1 background noise database.

Two modes of hands-free operation were used; the hand-held hands-free phone on a desktop and in front of the HATS as described in 3GPP TS 26.132 [5]:

- DUT in front of HATS "hand-held hands-free" (6 noise types plus silence).
- DUT positioned on a table "desktop hands-free" (one noise type plus silence).

In the desktop hands-free tests a 1 m x 1 m table was introduced with the DUT located on the table, 40 cm from the lower edge.

The room setups are shown in **Figure 56** and **Figure 57**.

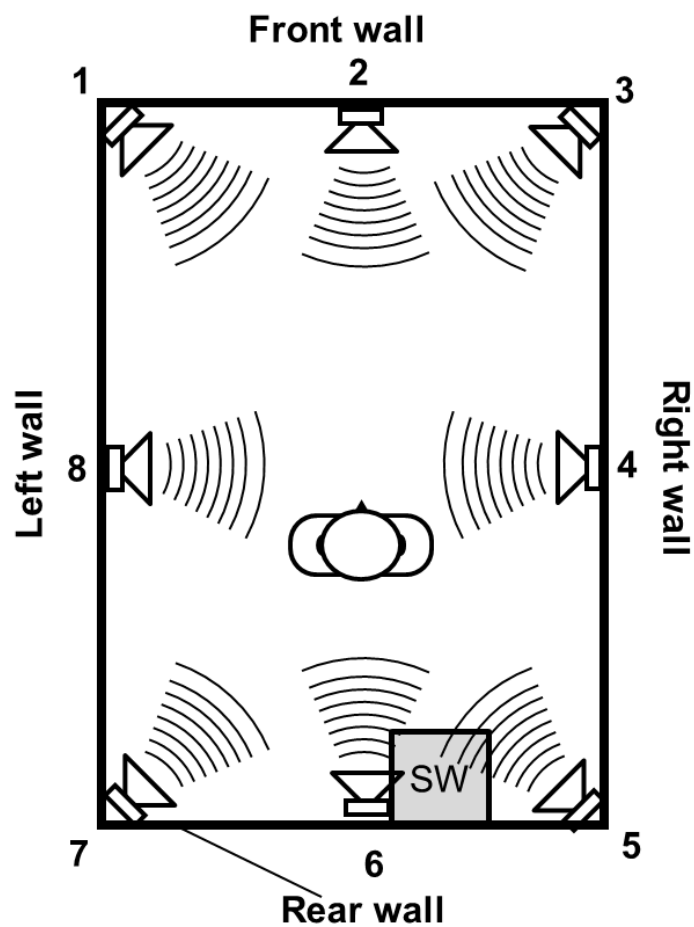

Figure 56: Speaker placement in room 1

Loudspeakers 1,3,5,7 were positioned in the corners of the room whereas loudspeakers 2, 4 and 8 were positioned in the midway on the edges. Because of the door of the room loudspeaker 6 is shifted slightly to the right. The subwoofer was positioned 90 cm from the right wall.

As the DUT was located in the mid of the room and the distance between DUT and HATS' MRP had to be 30 cm the HATS was located 135 cm from the rear wall and centered between the side walls.

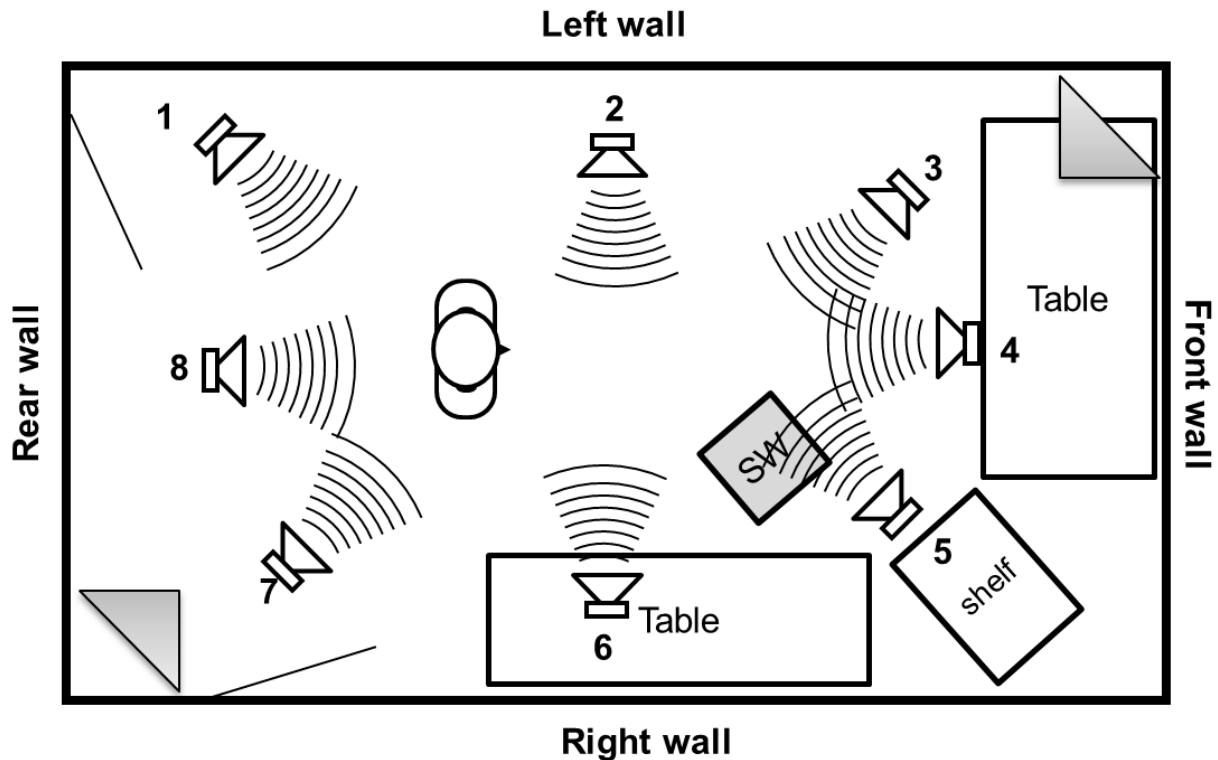

Figure 57: Speaker placement in room 2 which was acoustically treated, triangles in corner show positions of edge absorbers

The HEAD acoustics communication analysis system ACQUA with the background noise systems HAE-BGN and 3PASS were used. Nubert Loudspeakers were used (nuLine 24, WS-203, nuBox 381) For HAE-BGN a HEAD acoustics HSW 2.1 subwoofer was used. The test sequences were provided by HEAD acoustics. A HEAD acoustics HATS HMS II.3 was used on a torso box.

The mouth simulator of the HATS was calibrated at MRP using a 1/2-inch pressure-field microphone. The HFRP calibration was performed for the two different measurement distances, 30 and 50 cm. The HATS ears were calibrated.

The mouth simulator of the HATS was calibrated at MRP using a 1/2-inch pressure-field microphone.

For HAE-BGN the delays between the four loudspeakers which can be adapted to different rooms were chosen as follows:

- Front left: 0 ms, Front right: 11 ms
- Rear left: 17 ms, Rear right: 29 ms

These are the standard delays as described in [1].

All tests in this experiment were conducted in narrowband and wideband.

3.2 Equalization

In general, the equalization process for hands-free devices is identical to the equalization for hand-set type terminals for both 3PASS and HAE-BGN. As for handsets the 3PASS equalization procedure is completely automated. In difference to the equalization procedure for handsets, however, the microphone array MSA I is positioned at the location of the DUT as described in TS 103 224 [2]. The equalization and the measurement setups for the handheld hands-free devices are shown in shown in Figure 58, Figure 59 and Figure 60.

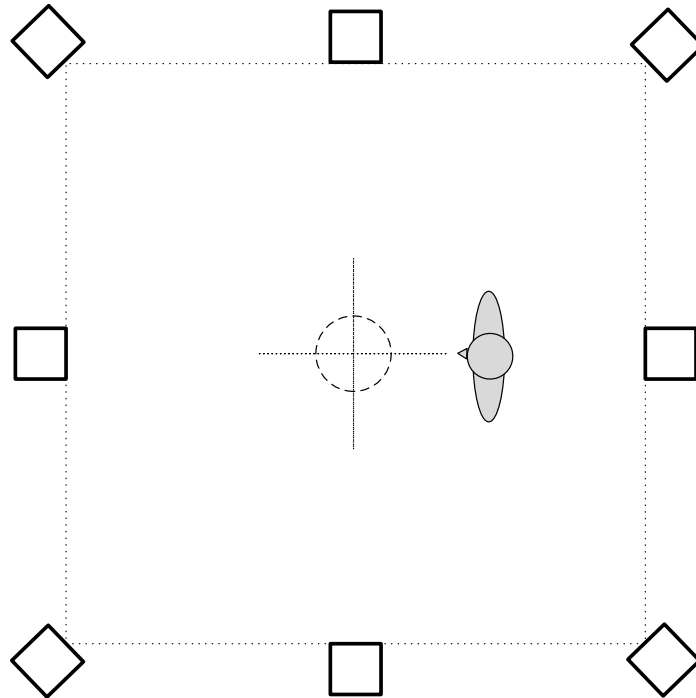

Figure 58: Equalization for hand-held hands-free devices using 3PASS according to TS 103 224, the circle indicates the microphone array used for the equalization ([5])

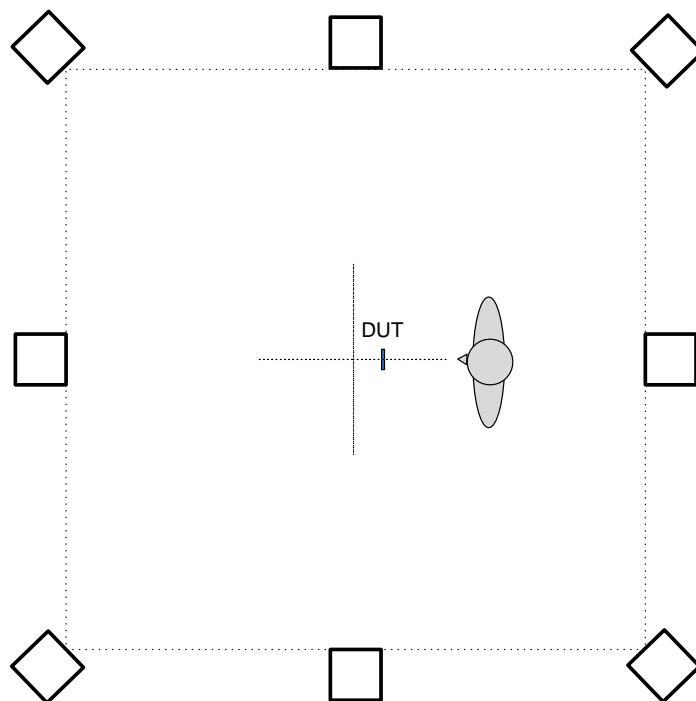

Figure 59: Measurement arrangement using 3PASS ([5])

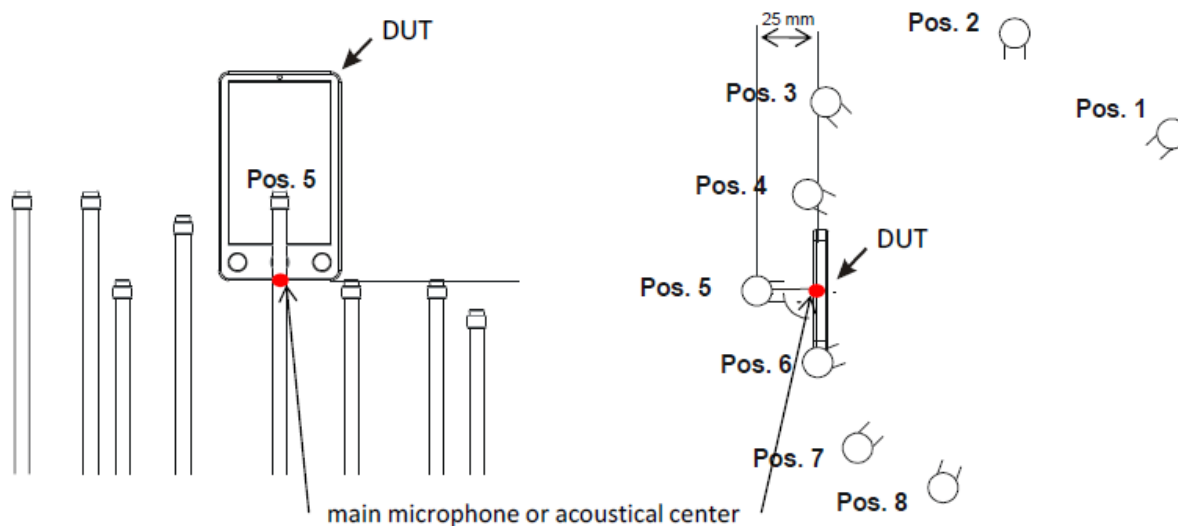

Figure 60: Detailed positioning of the hand-held hands-free ([2])

In case of desktop hands-free devices the setup is very similar except that a table of 1 m x 1 m is positioned in the room as described in the relevant standard – e.g. TS 26.132 [5] or ITU-T P.340 [12]. In our case a distance of 40 cm measured from the HATS torso was chosen. The array is positioned as described TS 103 224 (see)

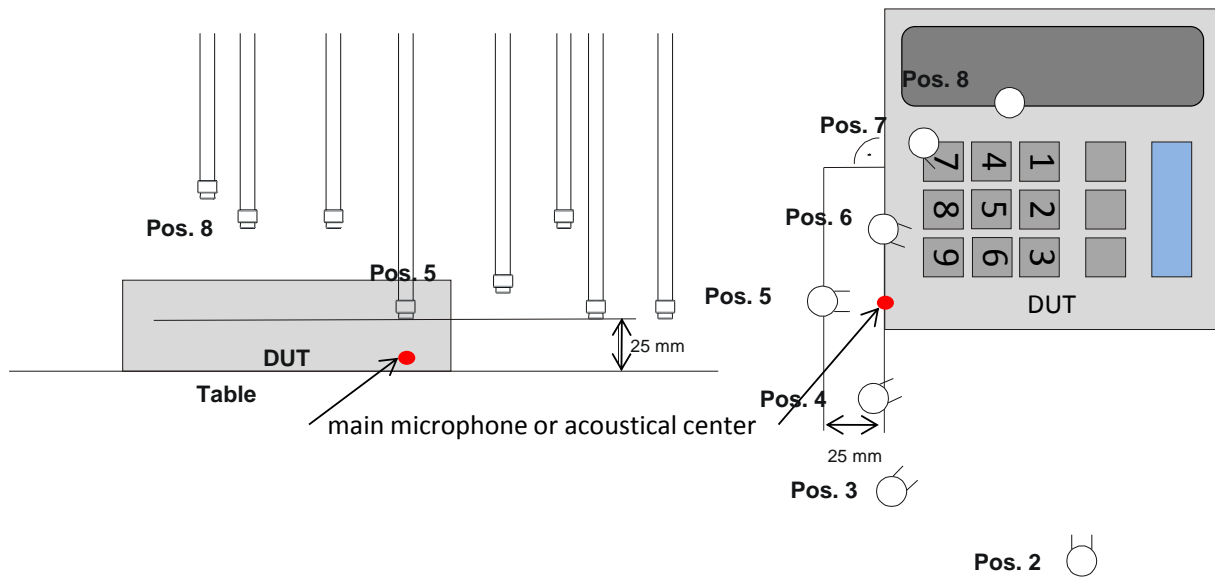

Figure 61: Detailed positioning of a desktop hands-free terminal ([2])

As for the equalization at the HATS position, in case the equalization procedure fails additional treatment of the room is needed. This includes the validation of the C80 criterion and the reverberation time, the application of additional damping material and the change of the loudspeaker position.

In contrast to the description in [1] the equalization with HAE-BGN was performed with HATS but at the location of the DUT as shown in Figure 62. The measurement setup is shown in Figure 63. By this procedure the sound-field is equalized closer to the DUT position as described in [1]. When testing a desktop hands-free device the measurements are conducted using a table of 1 m x 1 m as described above. In our experiment the same setup was used as described for the tests with 3PASS.

As for handset tests HAE-BGN also requires manual post-equalization for hands-free testing in order to minimize the cross-talk from the left channel signal to the right ear of the artificial head and vice versa. This procedure is described in the HAE-BGN manual [9]. If the equalization result is not satisfying, the delays between the loudspeakers and the loudspeaker positioning should be changed. The room treatment might need to be adapted in a similar way as it is described above for 3PASS.

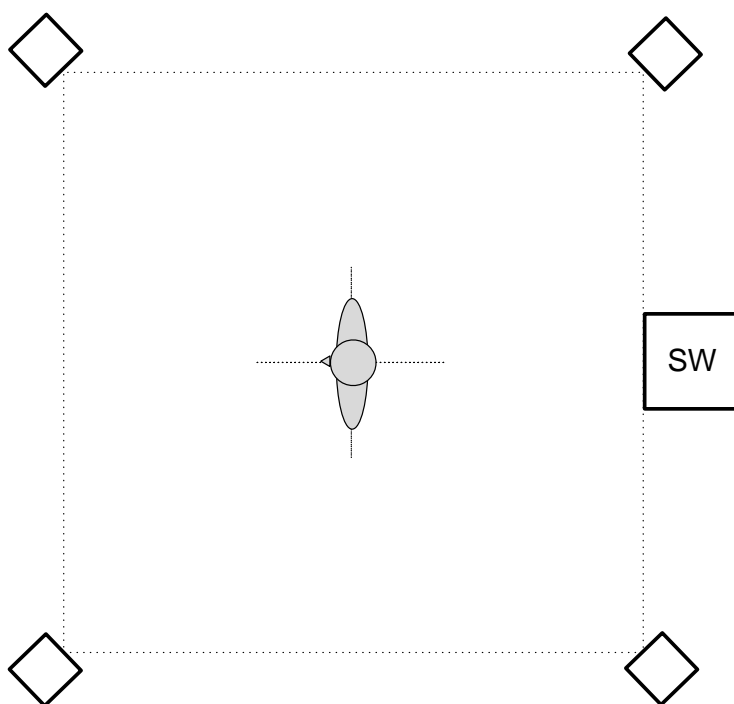

Figure 62: Equalization for hand-held hands-free devices using HAE-BGN ([5])

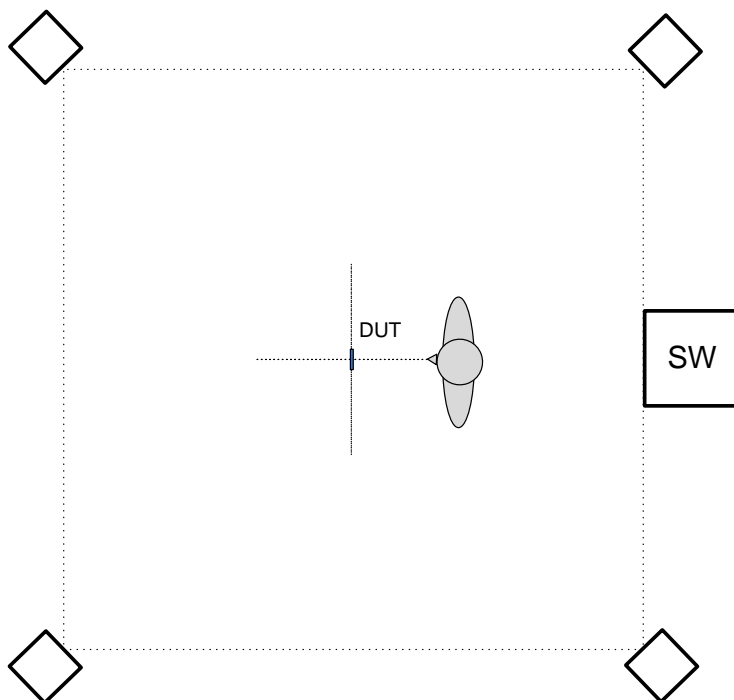

Figure 63: Measurements for hand-held hands-free devices using HAE-BGN ([5])

The validation of the equalization follows exactly the same procedure and documentation as described in the handset section (see chapter 2.2) and is not documented here again.

3.3 Test results hand-held hands-free (HHHF)

3.3.1 Comparison of Rooms

The following analyses compare the MOS-values measured in the two different rooms by plotting the measured MOS-value of room 1 on the x-axis versus the measured MOS-value of room 2 on the y-axis. As the N-MOS value is the value which is mostly affected by different background noises most attention is paid to this value.

3.3.1.1 Wideband

3.3.1.1.1 No background noise

The analysis without any background noise simulation present basically shows the variance to be expected between the different rooms. This variance may be influenced by:

- Calibration differences
- Setup differences
- Room differences
- Time variant behavior of the device under test

It seems that these parameters may have impact on the results in a similar range as the experiments including the background noise simulation. The RMSE ranges from 0.16 to 0.23.

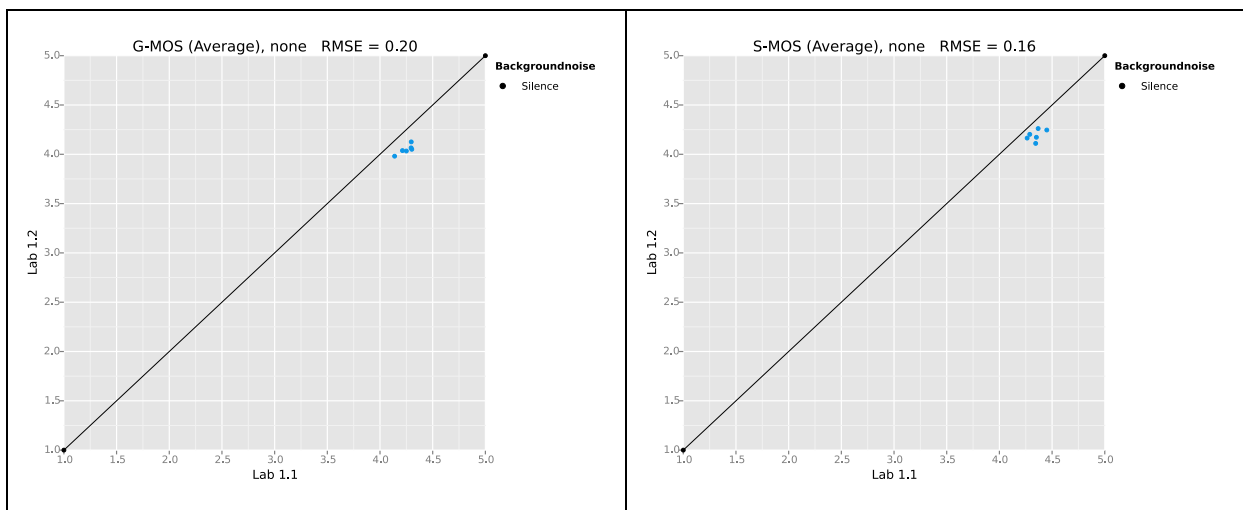

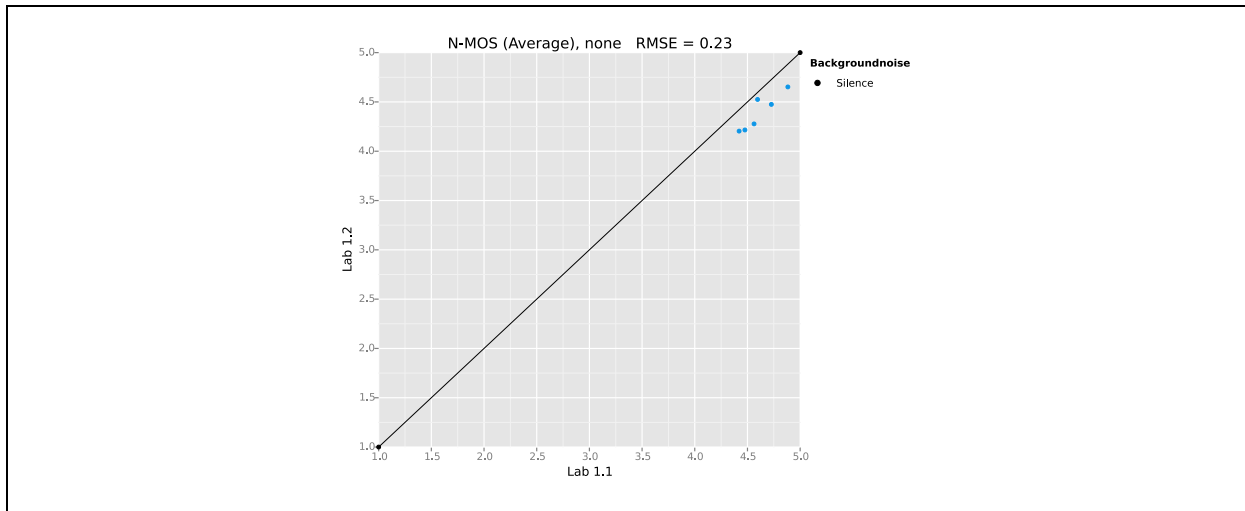

Figure 64: Correlation between MOS results from Lab 1.1 and Lab 2.1 (HHHF, Wideband)

3.3.1.1.2 Simulation using HAE-BGN acc. to ES 202 396-1

The results shown in this section are based on HAE-BGN using the binaurally recorded background noises in chapter 8.2 of EG 202 396-1 (noises equivalent to TS 103 224). The following observations can be made:

- RMSE ranges from 0.06 to 0.16
- The S-MOS values line up quite well.
- The N-MOS values show some scattering which results in an RMSE of 0.16

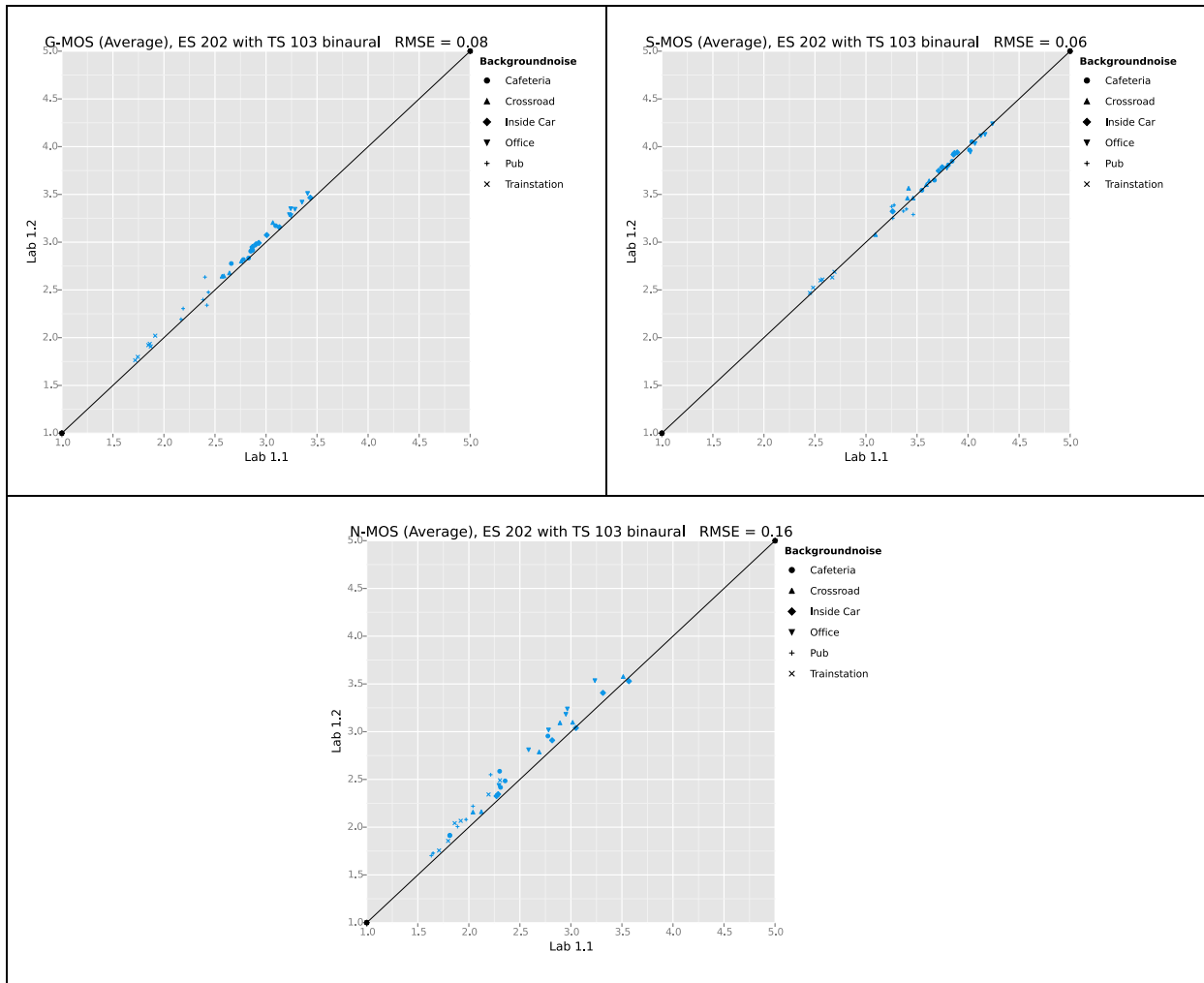

Figure 65: Correlation between MOS results from Lab 1.1 and Lab 2.1 (HHHF, Wideband)

3.3.1.1.3 Simulation using 3PASS acc. to TS 103 224

The results shown in this section are based on using 3PASS according to TS 103 224 as well as the background noises from this standard. For this setup the following observations can be made:

- RMSE ranges from 0.06 to 0.09
- The G-MOS lines up quite well
- The N-MOS has the lowest RMSE-value compared to the other simulation methods of about 0.09

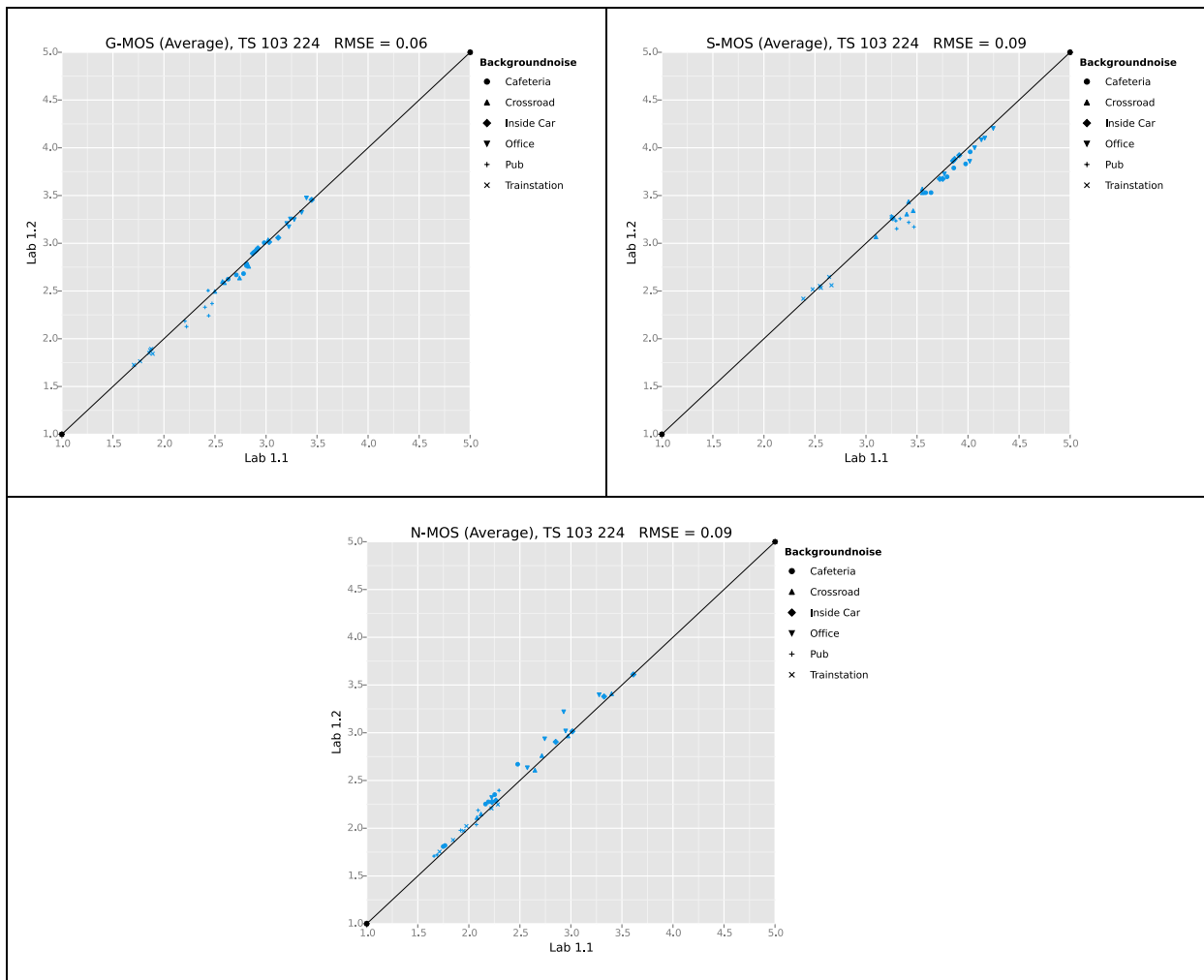

Figure 66: Correlation between MOS results from Lab 1.1 and Lab 2.1 (HHHF, Wideband)

3.3.1.2 Narrowband

3.3.1.2.1 No background noise

The analysis without any background noise simulation present basically shows the variance to be expected between the different rooms.

The reasons for the differences were already described in 3.3.1.1.

The RMSE ranges from 0.16 to 0.20.

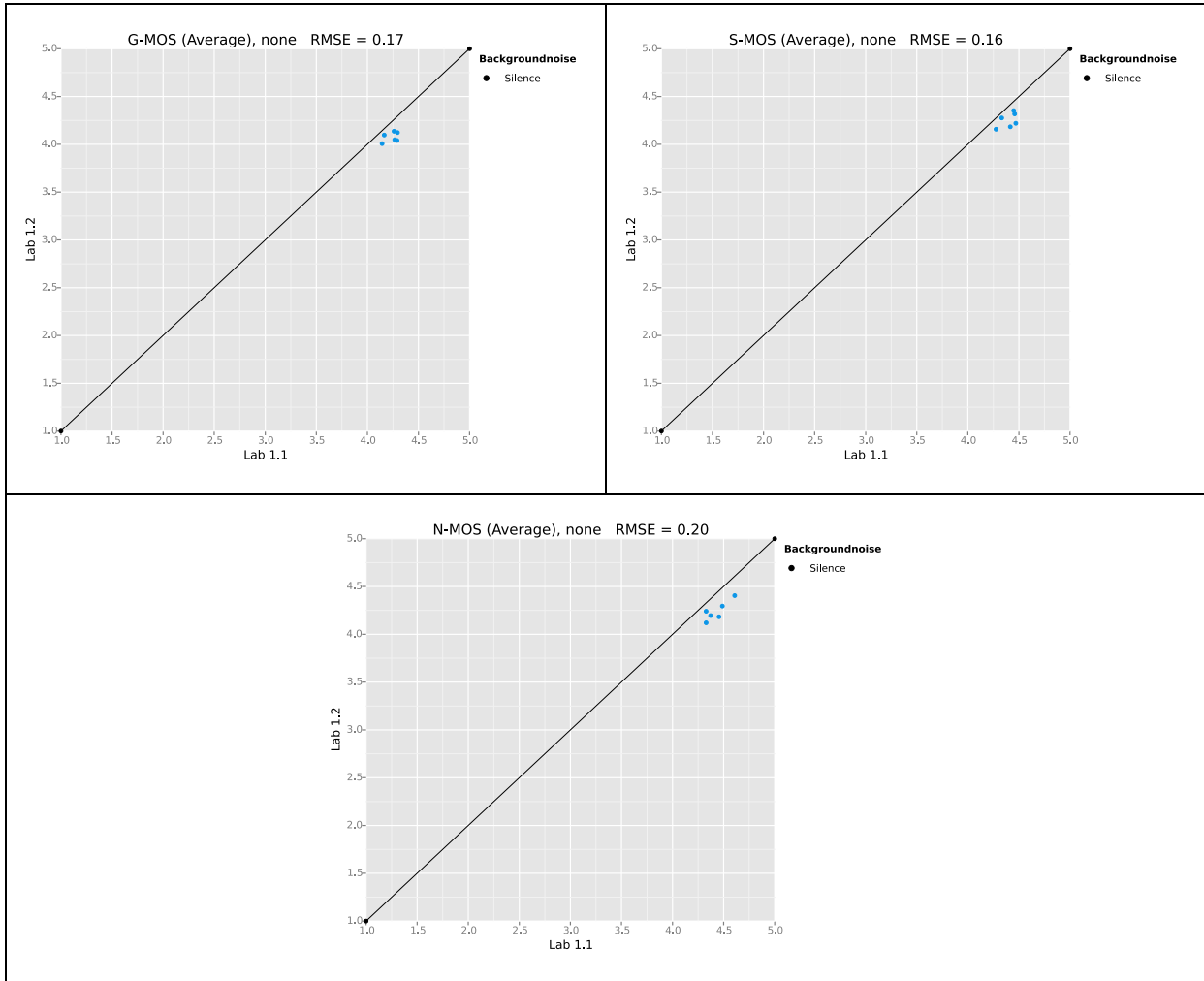

Figure 67: Correlation between MOS results from Lab 1.1 and Lab 2.1 (HHHF, Narrowband)

3.3.1.2.2 Simulation using HAE-BGN acc. to ES 202 396-1

The results shown in this section are based on using HAE-BGN and the binaurally recorded background noises in chapter 8.2 of EG 202 396-1 (noises equivalent to TS 103 224). The following observations can be made:

- RMSE ranges from 0.09 to 0.19.
- Also a rather high RMSE of 0.19 can be observed for the N-MOS results.

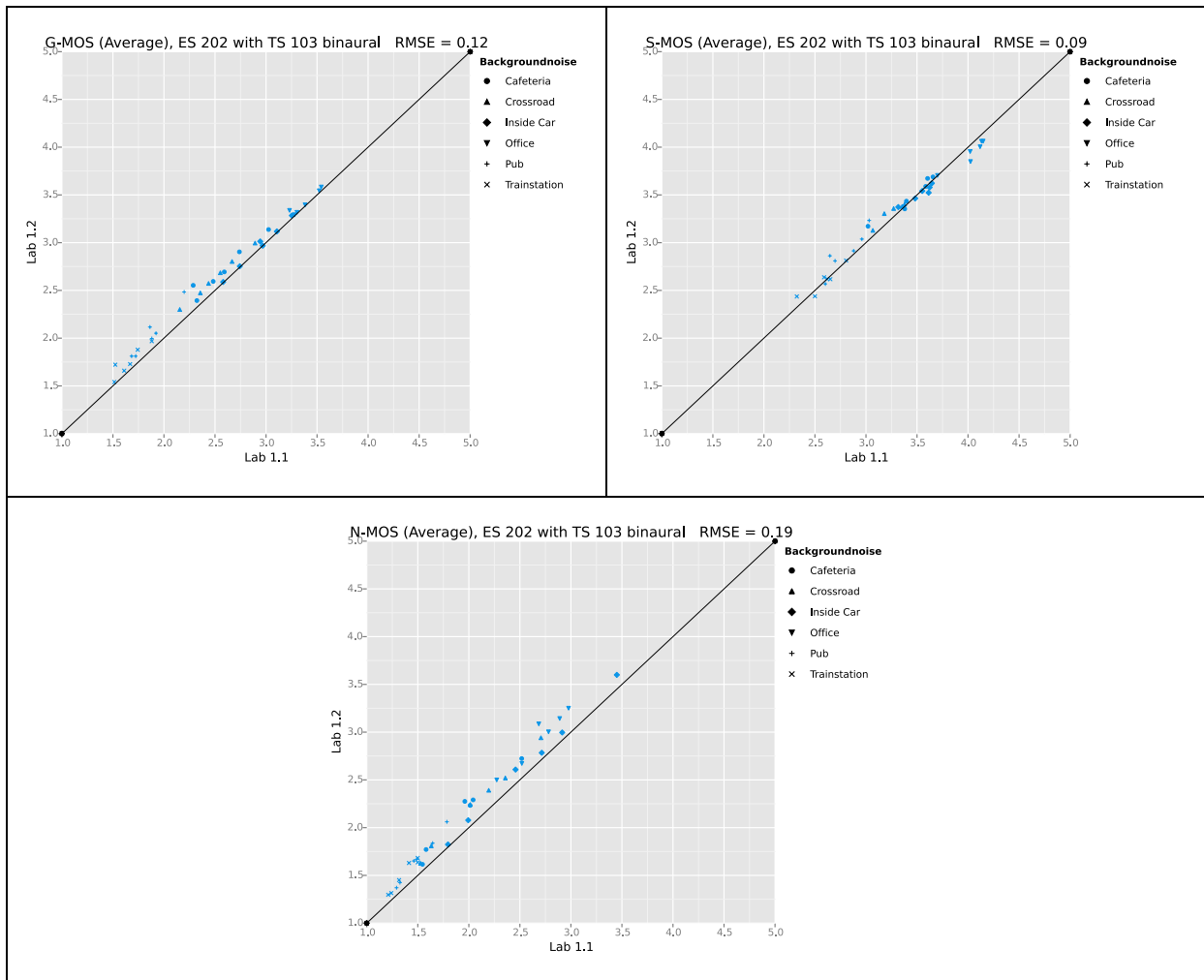

Figure 68: Correlation between MOS results from Lab 1.1 and Lab 2.1 (HHHF, Narrowband)

3.3.1.2.3 Simulation using 3PASS acc. to TS 103 224

The results shown in this section are based on using the TS 103 224 simulation as well as the background noises from this standard. For this setup the following observations can be made:

- RMSE ranges from 0.07 to 0.13.
- Compared to the other methods the RMSE of the N-MOS results is quite low at 0.07.

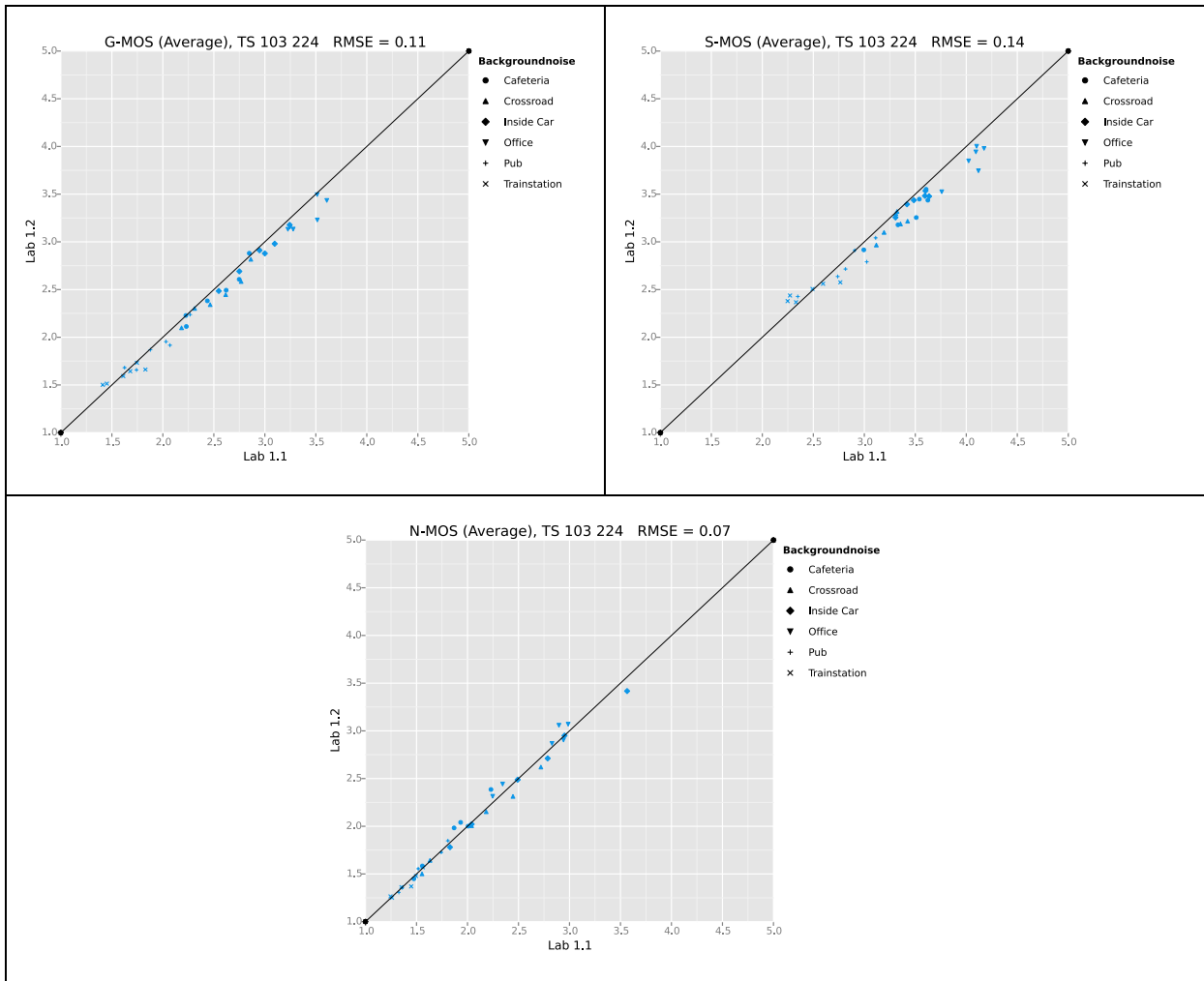

Figure 69: Correlation between MOS results from Lab 1.1 and Lab 2.1 (HHHF, Narrowband)

3.3.2 Comparison of average S- N- and G-MOS results in different rooms using 3PASS and HAE-BGN

3.3.2.1 Wideband

This analysis shows the absolute MOS-values measured in the different rooms averaged over all background noises for every simulation method as required e.g. in TS 26.131. The following observations can be made:

- S-MOS and N-MOS are always somewhat higher in room 2.
- As already seen in the previous chapter N-MOS shows higher differences between the different rooms of up to about 0.3 dB when using HAE-BGN (acc. to ES 202 396-1) whereas the difference is lowest for the method 3PASS (acc. to TS 103 224).

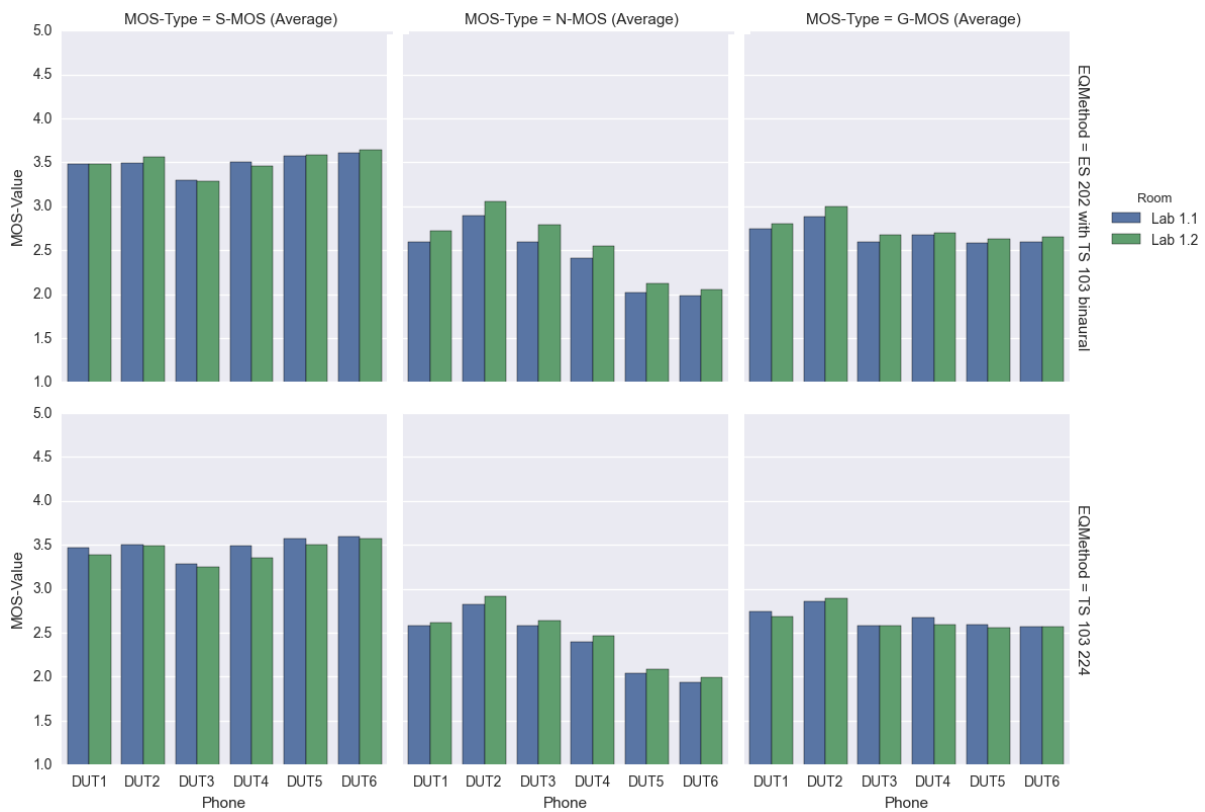

Figure 70: Differences of MOS-values between 3PASS and HAE-BGN background noise simulation (HHHF, Wideband)

3.3.2.2 Narrowband

This analysis shows the absolute MOS-values measured in the different rooms averaged over all background noises for every simulation method. The following observations can be made:

- S-MOS and N-MOS is always higher in room 2
- As already seen in the previous chapter N-MOS shows higher differences between the different rooms of up to about 0.4 dB when using HAE-BGN (acc. to ES 202 396-1) whereas the difference is lowest for the method 3PASS (acc. to TS 103 224).

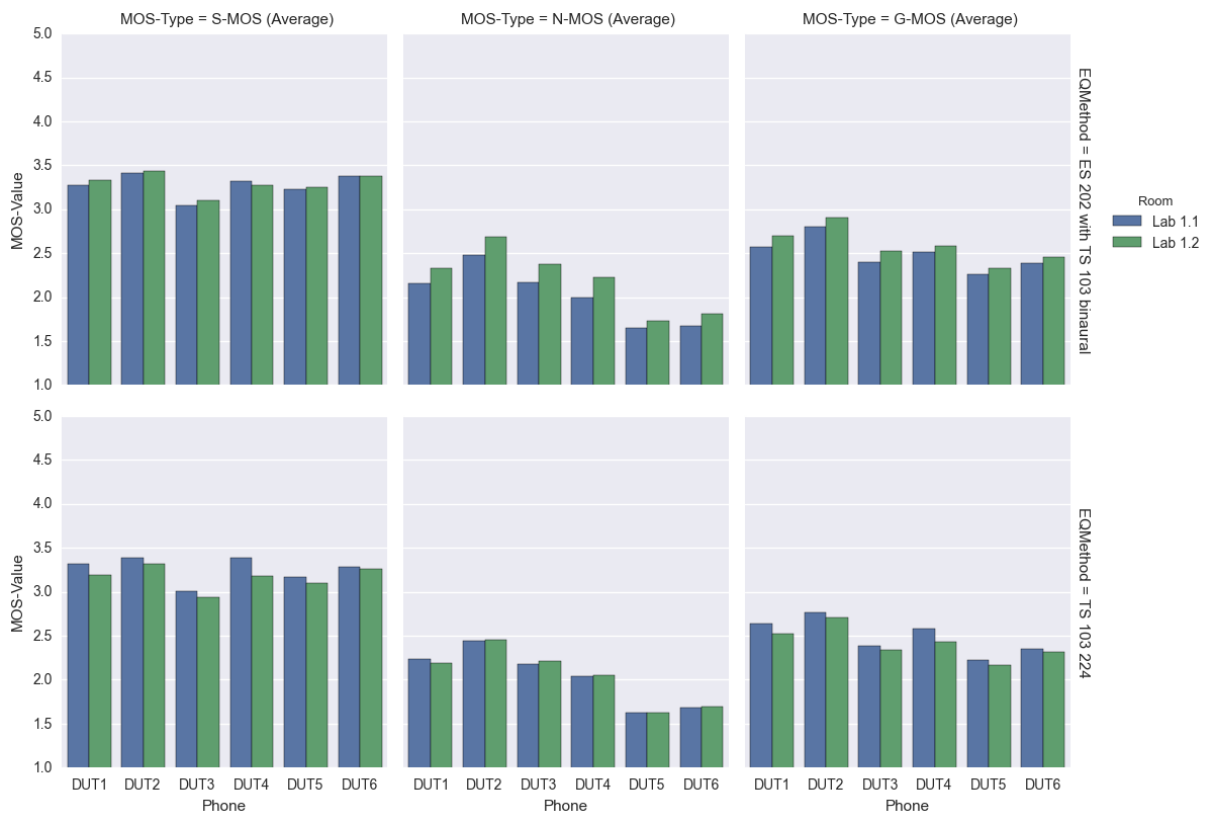

Figure 71: Differences of MOS-values between method from TS 103 224 and method from ES 202 396-1 (HHHF, Narrowband)

3.3.3 Analyses of the noise spectra reproduced at the reference microphone

The following two chapters show the noise spectra recorded at a reference microphone which was located close to the main microphone of the DUT. This reference is positioned close to the main microphone of the DUT microphone and is used e.g. to record the unprocessed signal plus noise for 3QUEST [10]. All available measurements for all 6 DUTs in both rooms are plotted into one diagram which means that one diagram contains 12 curves.

It can be seen that the differences in the case of the HAE-BGN based simulation acc. to ES 202 396-1 are quite big (about 7 dB) in contrast to the differences which can be observed for the 3PASS simulation acc. to TS 103 224 (about 2 dB). The accuracy of the 3PASS background noise simulation is significantly higher. This is valid for all background noises.

3.3.3.1 Simulation & noises using HAE-BGN acc. to ES 202 396-1

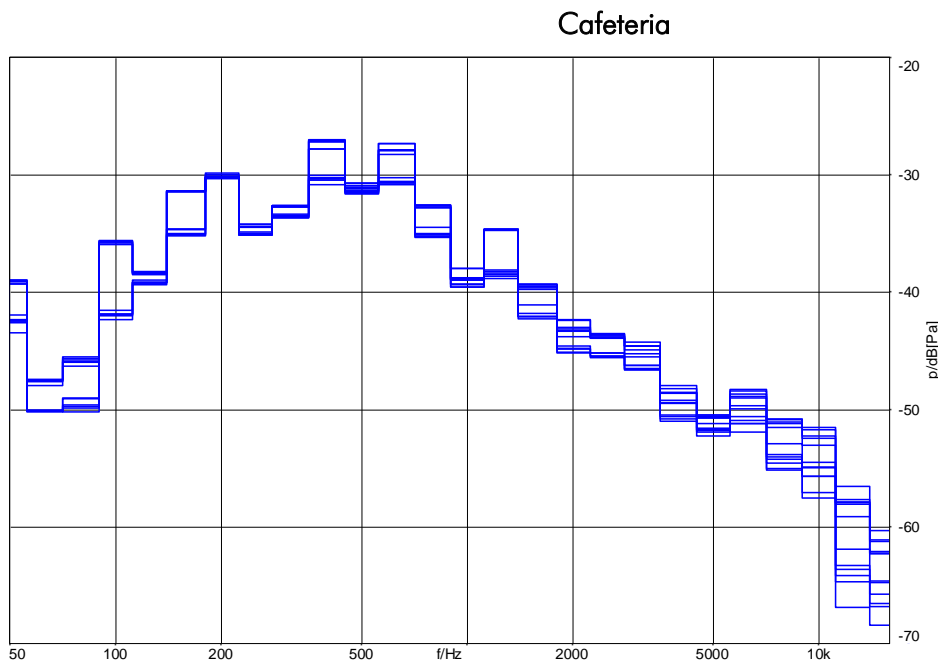

Figure 72: All spectra recorded at the reference microphone for cafeteria noise in 1/3rd octave (HHHF)

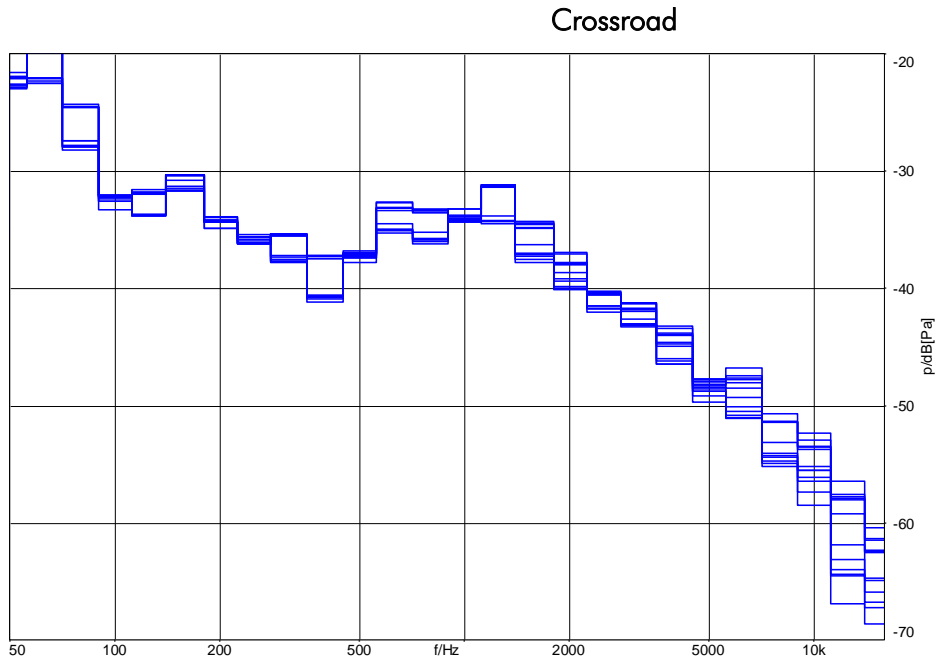

Figure 73: All spectra recorded at the reference microphone for crossroad noise in 1/3rd octave (HHHF)

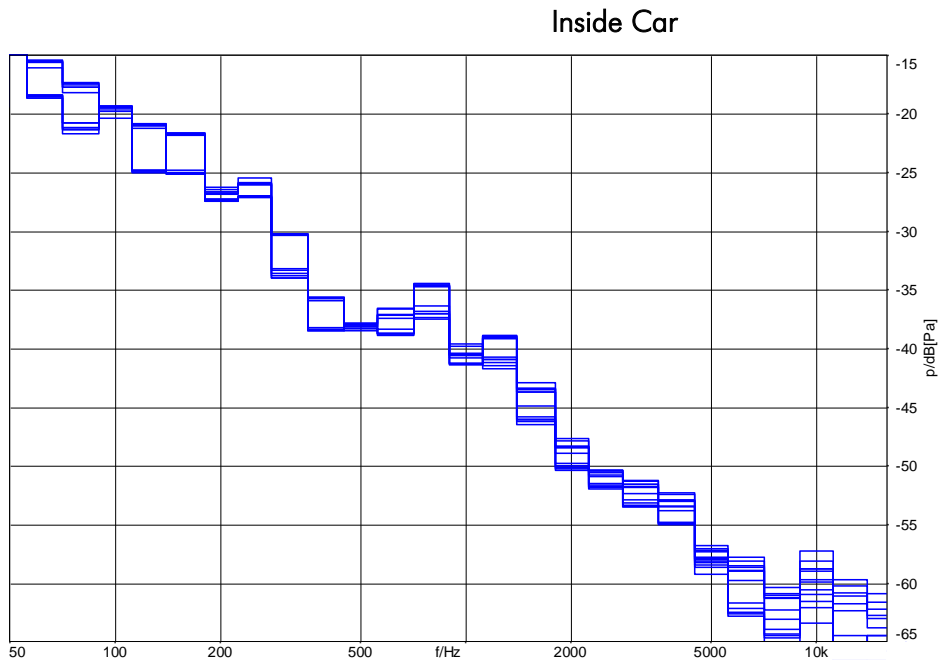

Figure 74: All spectra recorded at the reference microphone for inside car in 1/3rd octave (HHHF)

Office

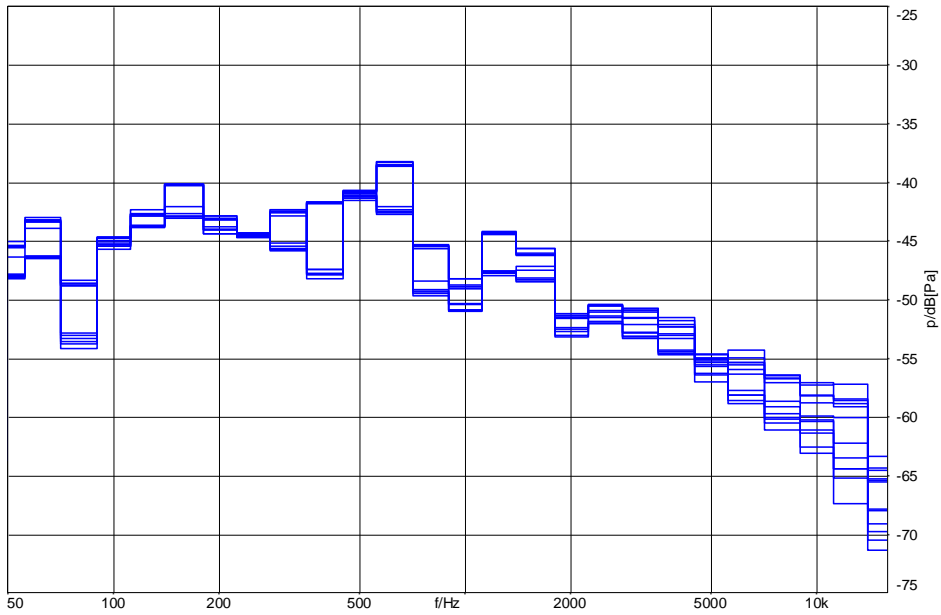

Figure 75: All spectra recorded at the reference microphone for office noise in 1/3rd octave (HHHF)

Pub

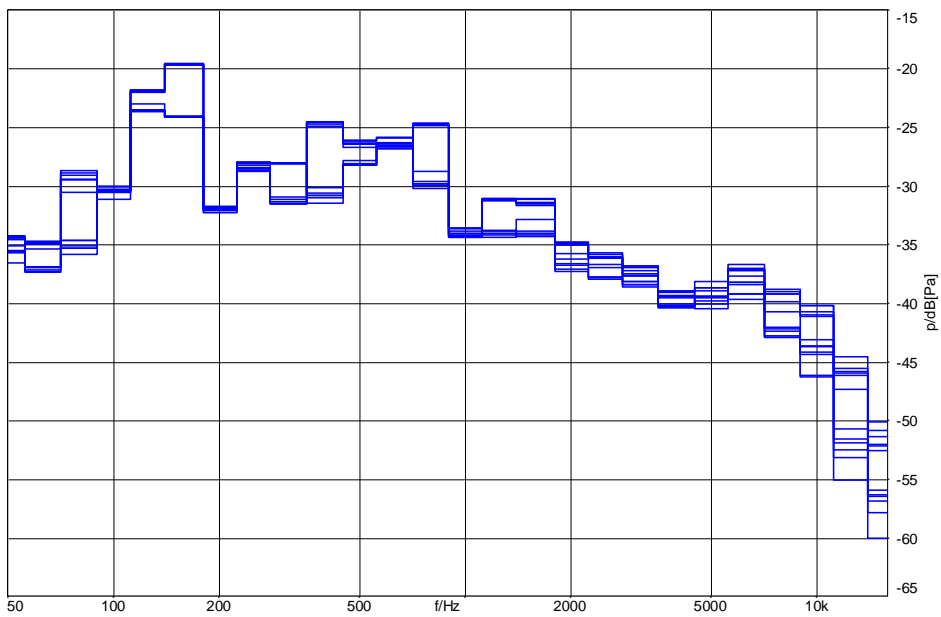

Figure 76: All spectra recorded at the reference microphone for pub noise octave (HHHF)

Trainstation

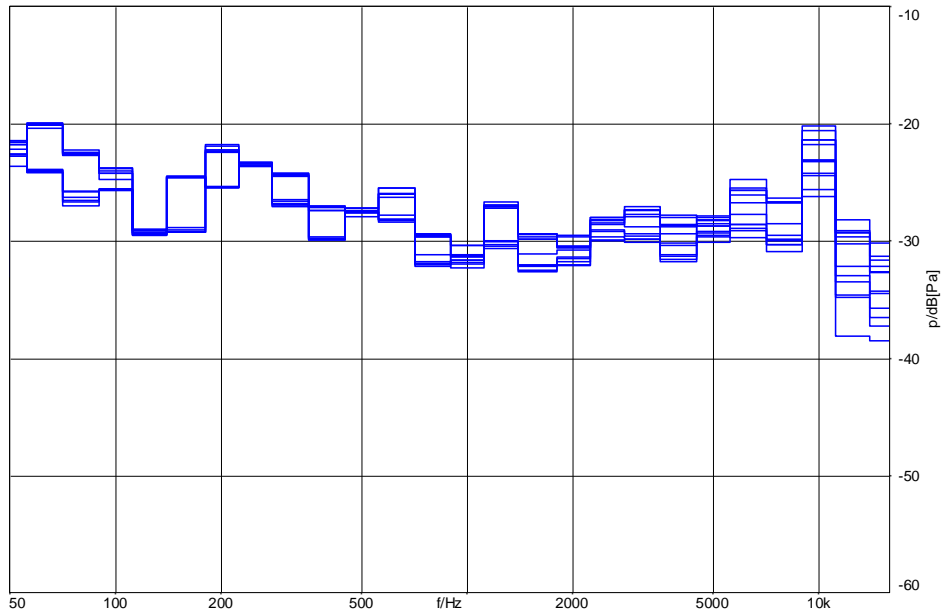

Figure 77: All spectra recorded at reference microphone for train station noise in 1/3rd octave (HHHF)

3.3.4 Simulation & noises acc. to TS 103 224

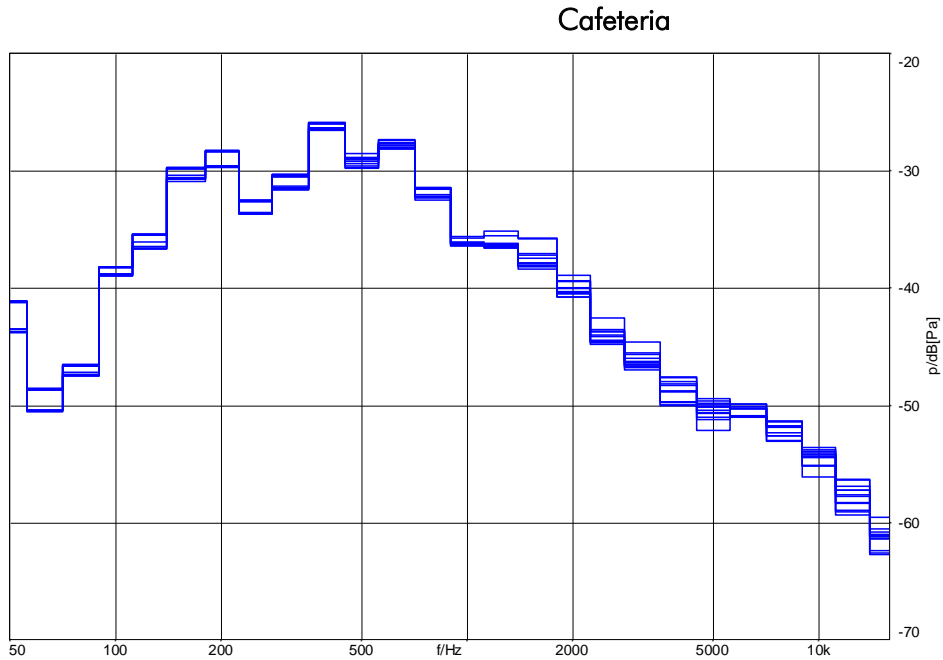

Figure 78: All spectra recorded at the reference microphone for cafeteria noise with method from TS 103 224 in 1/3rd octave (HHHF)

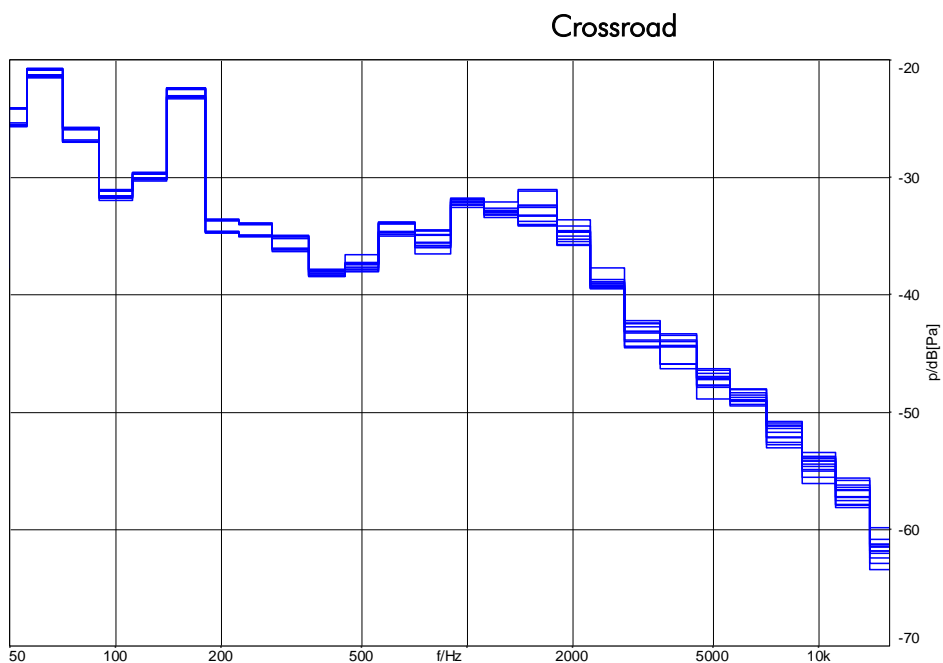

Figure 79: All spectra recorded at reference microphone for crossroad noise with method from TS 103 224 in 1/3rd octave (HHHF)

Inside Car

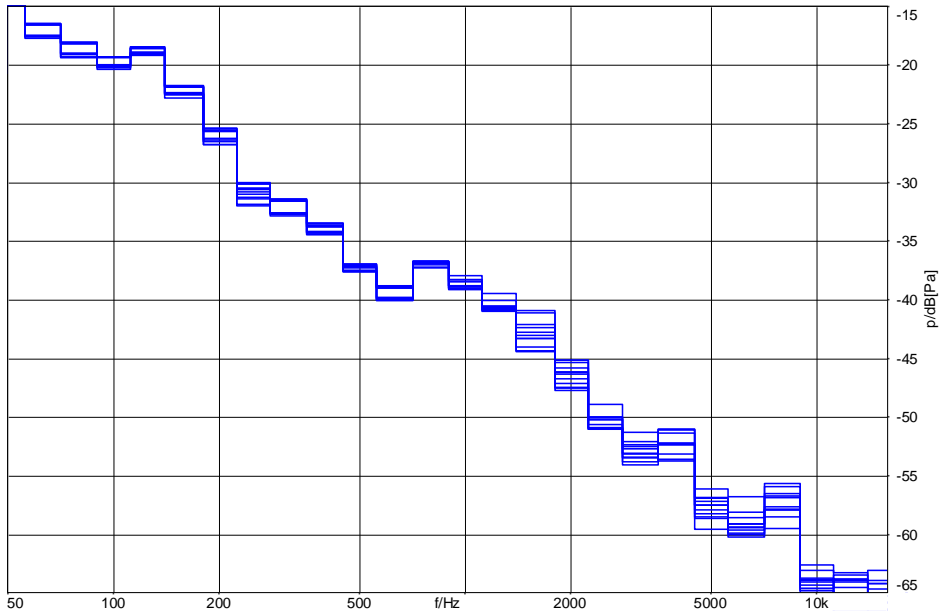

Figure 80: All spectra recorded at the reference microphone for inside car noise with method from TS 103 224 in 1/3rd octave (HHHF)

Office

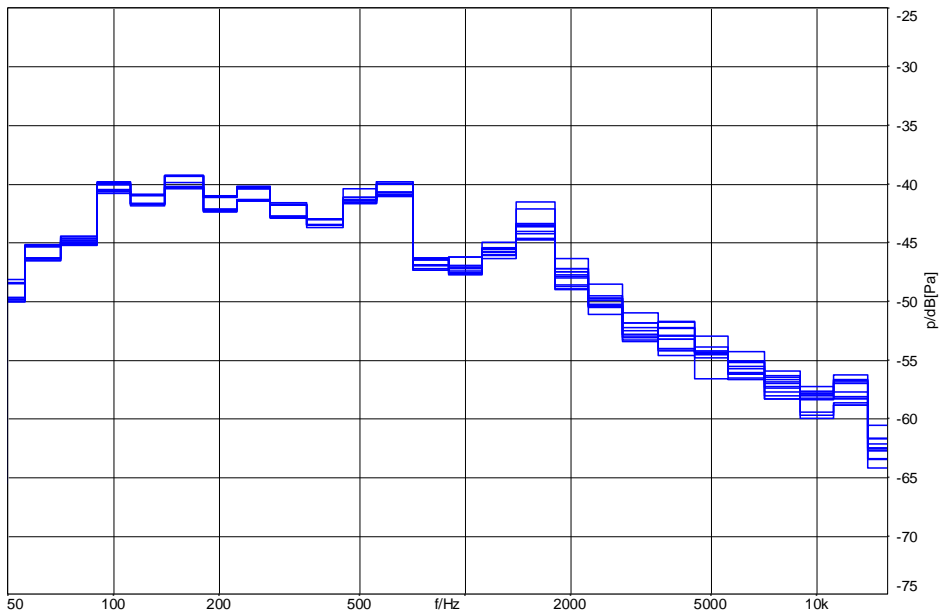

Figure 81: All spectra recorded at the reference microphone for office noise with method from TS 103 224 in 1/3rd octave (HHHF)

Pub

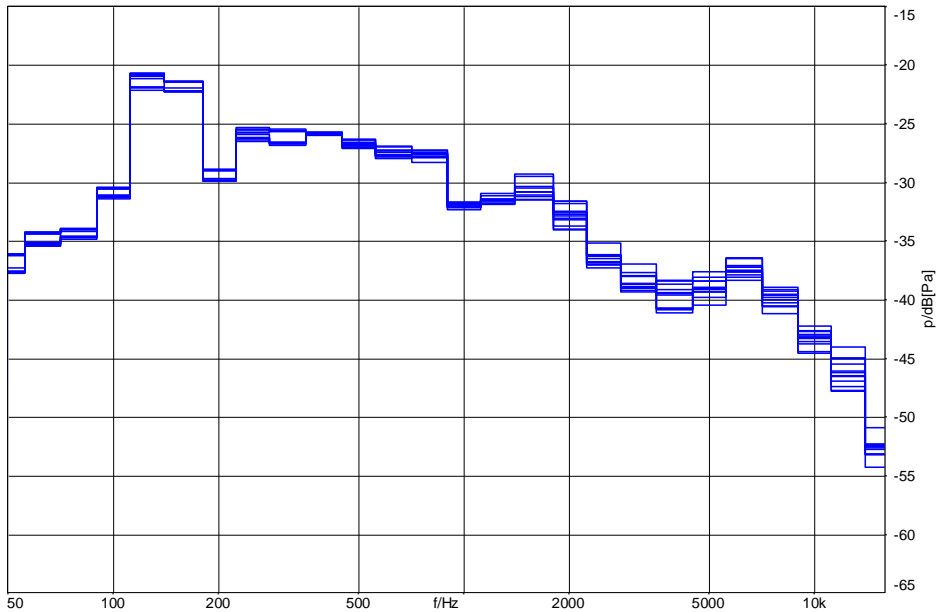

Figure 82: All spectra recorded at the reference microphone for pub noise with method from TS 103 224 in 1/3rd octave (HHHF)

Trainstation

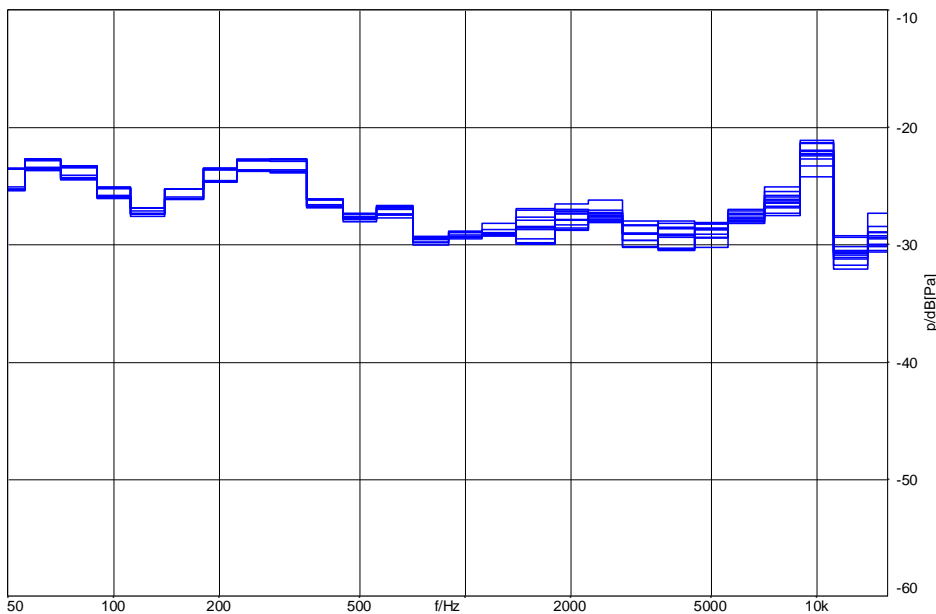

Figure 83: All spectra recorded at the reference microphone for train station noise with method from TS 103 224 in 1/3rd octave (HHHF)

3.4 Test results desktop hands-free (DTHF)

3.4.1 Comparison of Rooms

The following analyses compare the MOS-values measured in the two different rooms by plotting the measured MOS-value of room 1 on the x-axis versus the measured MOS-value of room 2 on the y-axis. As the N-MOS value is the value which is mostly affected by different background noises, most attention is paid to this value.

3.4.1.1 Wideband

3.4.1.1.1 No background noise

The analysis without any background noise simulation present basically shows the variance to be expected between the different rooms.

The reasons for the differences observed correspond to those already described in 3.3.1.1:

- Calibration differences
- Setup differences
- Room differences
- Time variant behavior of the device under test

It seems that these parameters may have impact on the results in a similar range as the experiments including the background noise simulation. The RMSE ranges from 0.24 to 0.33. All MOS-results are slightly worse in room 2.

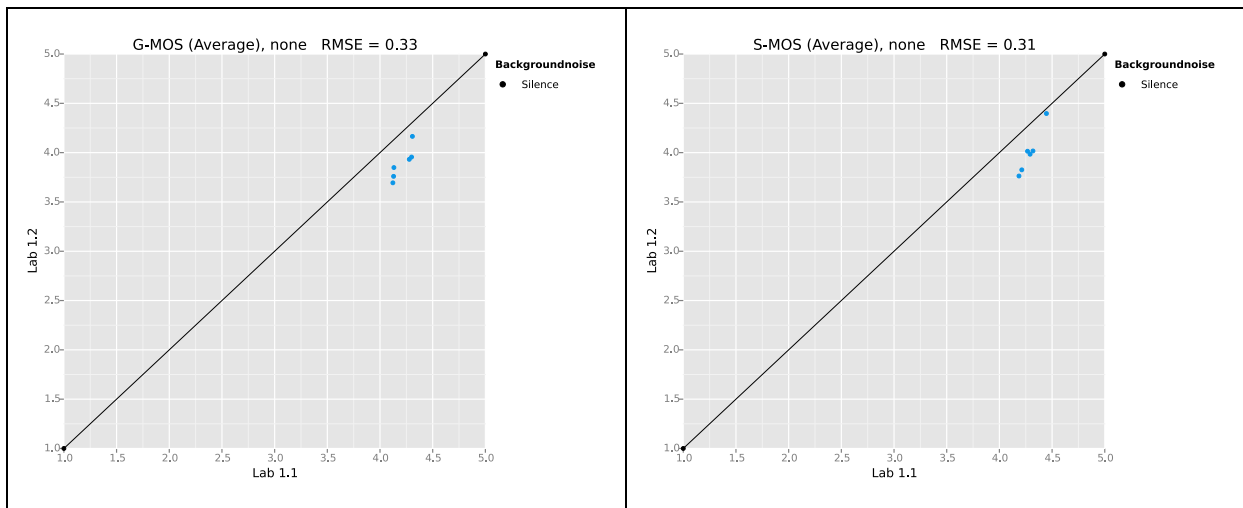

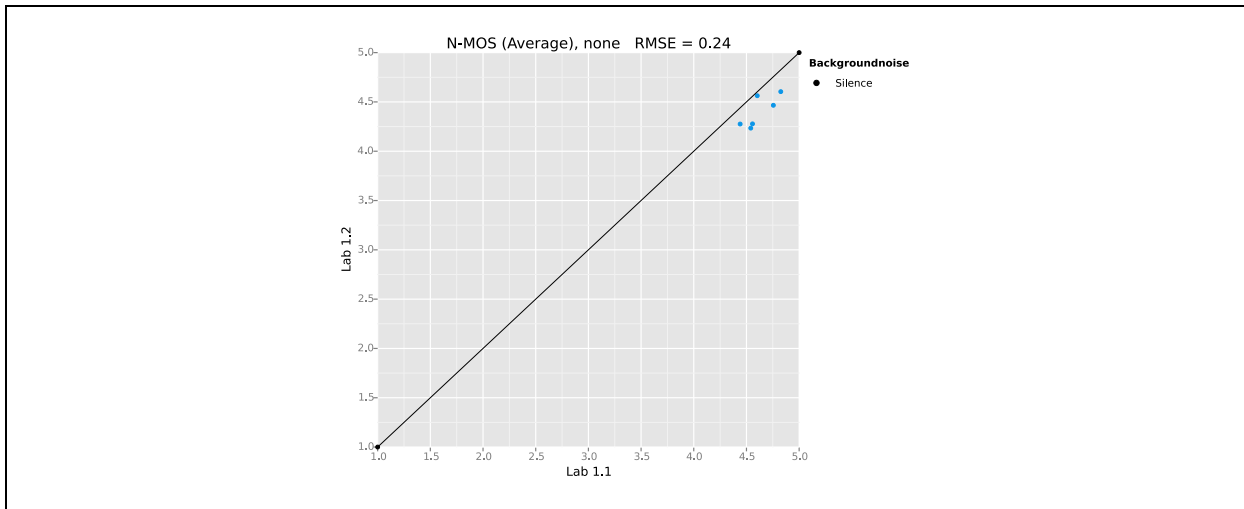
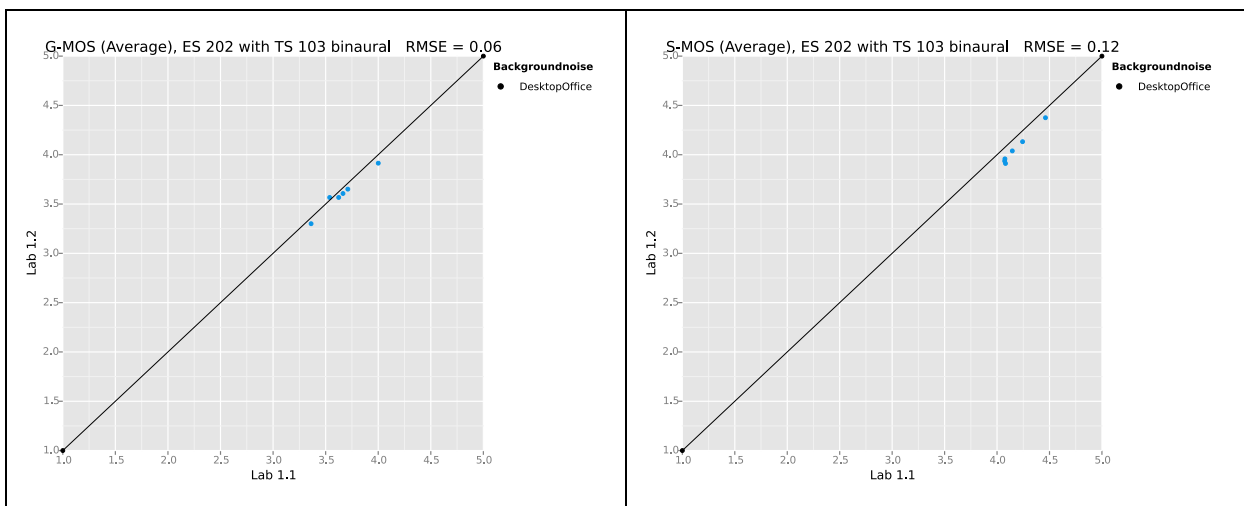

Figure 84: Correlation between MOS results from both rooms (DTHF, Wideband)

3.4.1.1.2 Simulation using HAE-BGN acc. to ES 202 396-1

The results shown in this section are based on HAE-BGN using the binaurally recorded background noises in chapter 8.2 of EG 202 396-1 (noises equivalent to TS 103 224). The following observations can be made:

- RMSE ranges from 0.06 to 0.17
- G-MOS results line up very well
- A slight offset can be observed for the S-MOS results
- N-MOS results are slightly scattered, resulting in an RMSE of 0.17



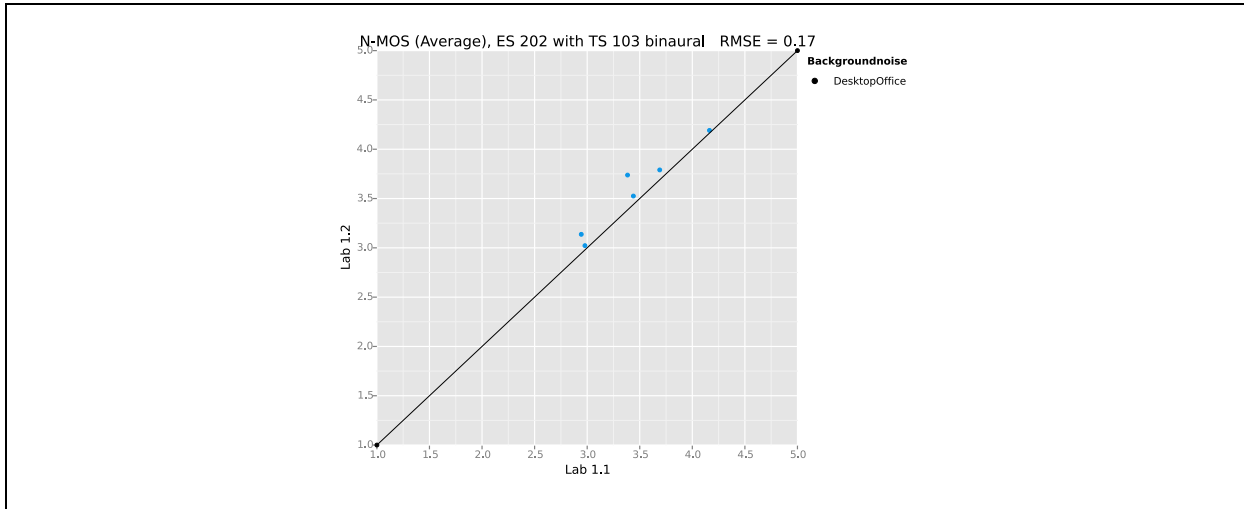
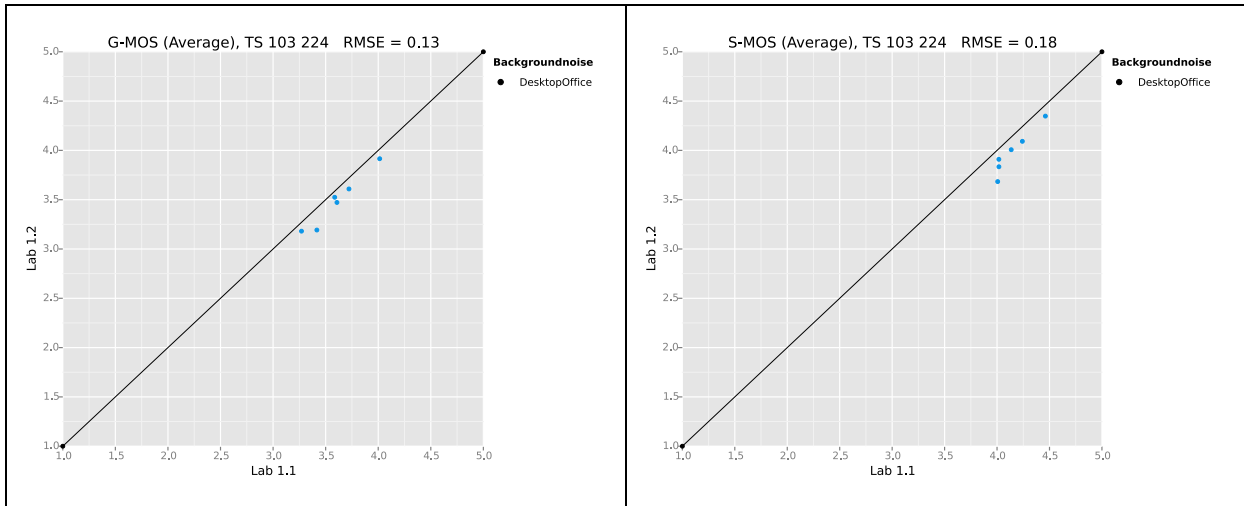

Figure 85: Correlation between MOS results from both rooms (DTHF, Wideband)

3.4.1.1.3 Simulation using 3PASS acc. to TS 103 224

The results shown in this section are based on using the TS 103 224 Simulation as well as the background noises from this standard. For this setup the following observations can be made:

- RMSE ranges from 0.05 to 0.10
- N-MOS results line up quite well in contrast to the method from ES 202 396-1 resulting in an RMSE of 0.09.



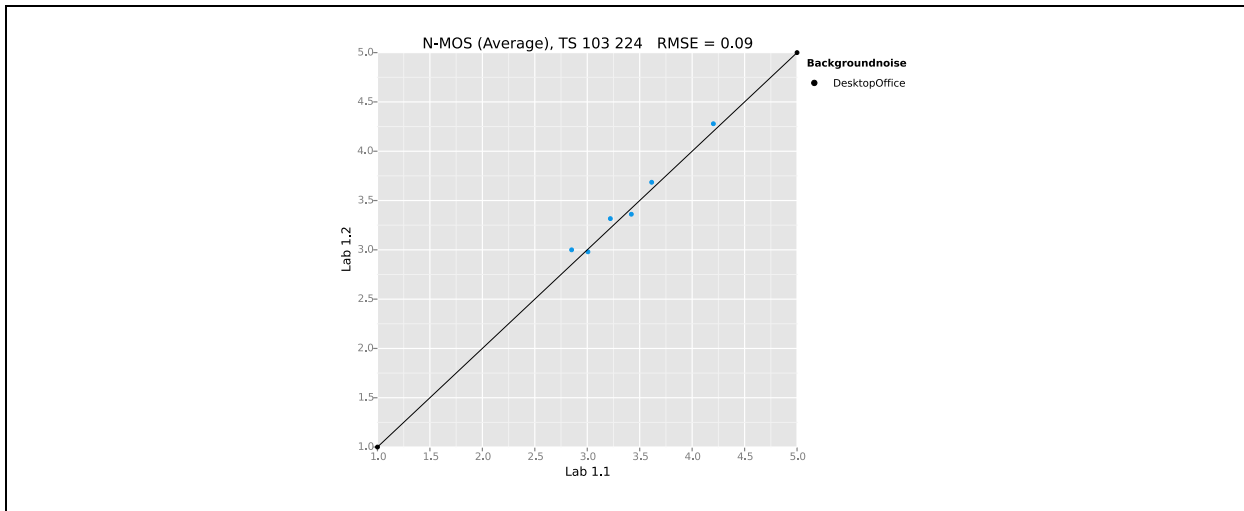

Figure 86: Correlation between MOS results from both rooms (DTHF, Wideband)

3.4.1.2 Narrowband

3.4.1.2.1 No background noise

The analysis without any background noise simulation present basically shows the variance to be expected between the different rooms.

The reasons for the differences were already described in 3.3.1.1.

The RMSE ranges from 0.28 to 0.49. All MOS-results are slightly worse in room 2.

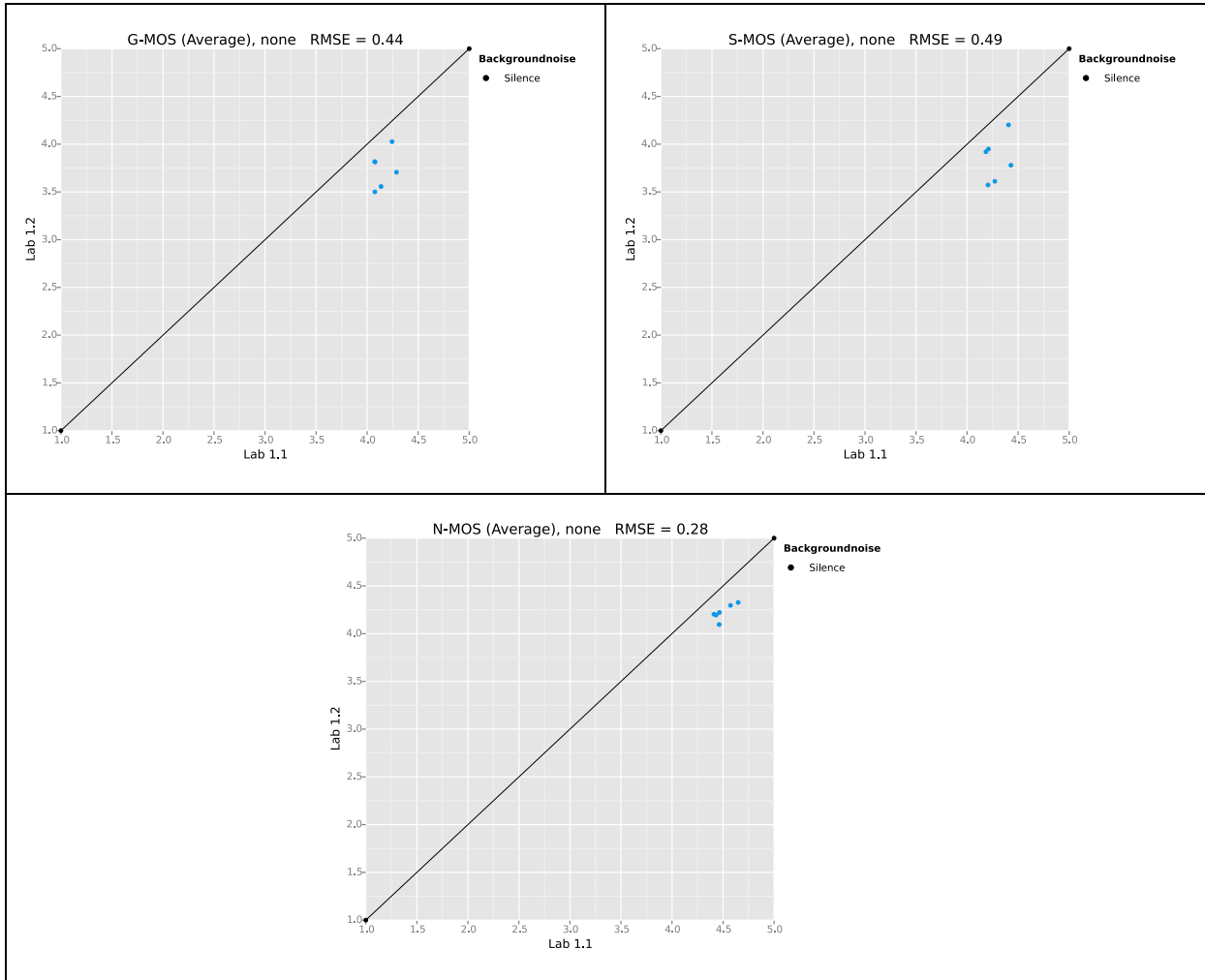

Figure 87: Correlation between MOS results from both rooms (DTHF, Narrowband)

3.4.1.2.2 Simulation using HAE-BGN acc. to ES 202 396-1

The results shown in this section are based on using HAE-BGN and the binaurally recorded background noises in chapter 8.2 of EG 202 396-1 (noises equivalent to TS 103 224). The following observations can be made:

- RMSE ranges from 0.23 to 0.40.
- Rather large offset for S-MOS.
- N-MOS scattered resulting in RMSE of 0.23.

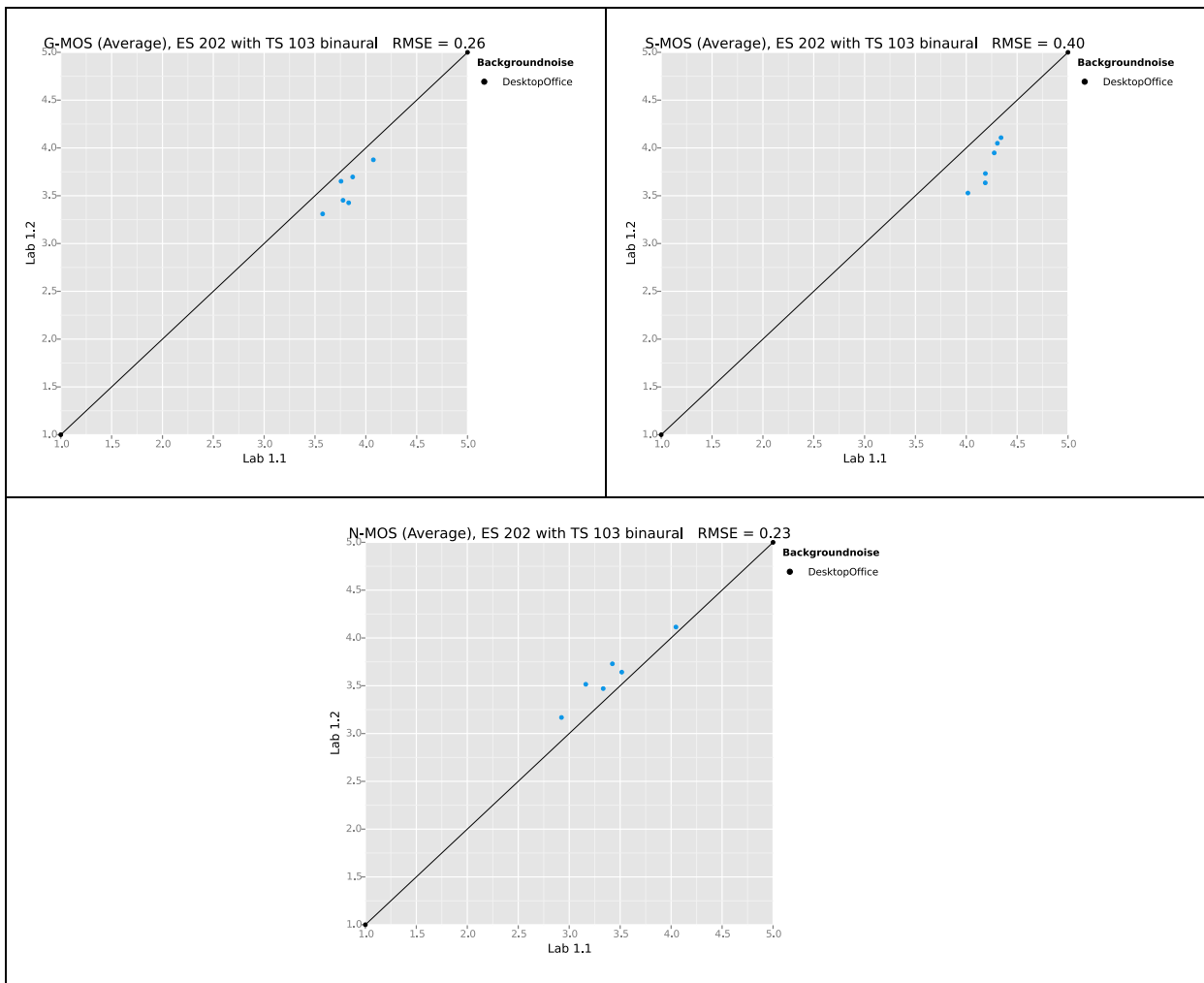

Figure 88: Correlation between MOS results from both rooms (DTHF, Narrowband)

3.4.1.2.3 Simulation using 3PASS acc. to TS 103 224

The results shown in this section are based on using the TS 103 224 simulation as well as the background noises from this standard. For this setup the following observations can be made:

- RMSE ranges from 0.16 to 0.42
- The N-MOS results line up pretty well in contrast to using HAE-BGN acc. to ES 202-396-1.

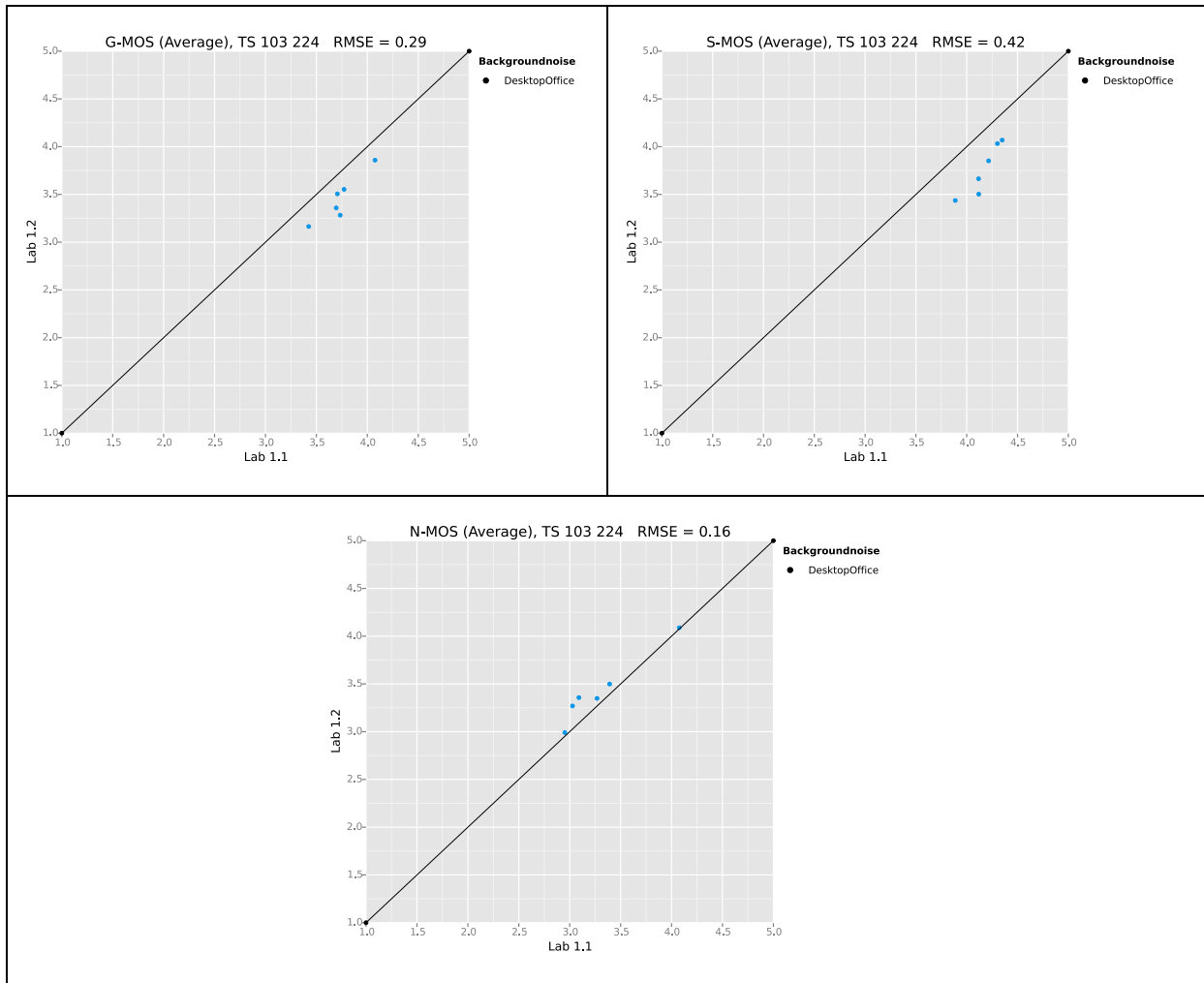

Figure 89: Correlation between MOS results from both rooms (DTHF, Narrowband)

3.4.2 Comparison of average S- N- and G-MOS results in different rooms using 3PASS and HAE-BGN Comparison of equalization methods

3.4.2.1 Wideband

The analysis shows the absolute MOS-values measured in the different rooms averaged over all background noises for every simulation method. The following observations can be made:

- G-MOS and S-MOS are always somewhat higher in room 1.
- In contrast N-MOS is generally higher better in room 2.
- The room dependent differences observed with 3PASS background noise simulation for N-MOS are generally somewhat lower than with HAE-BGN background noise simulation.

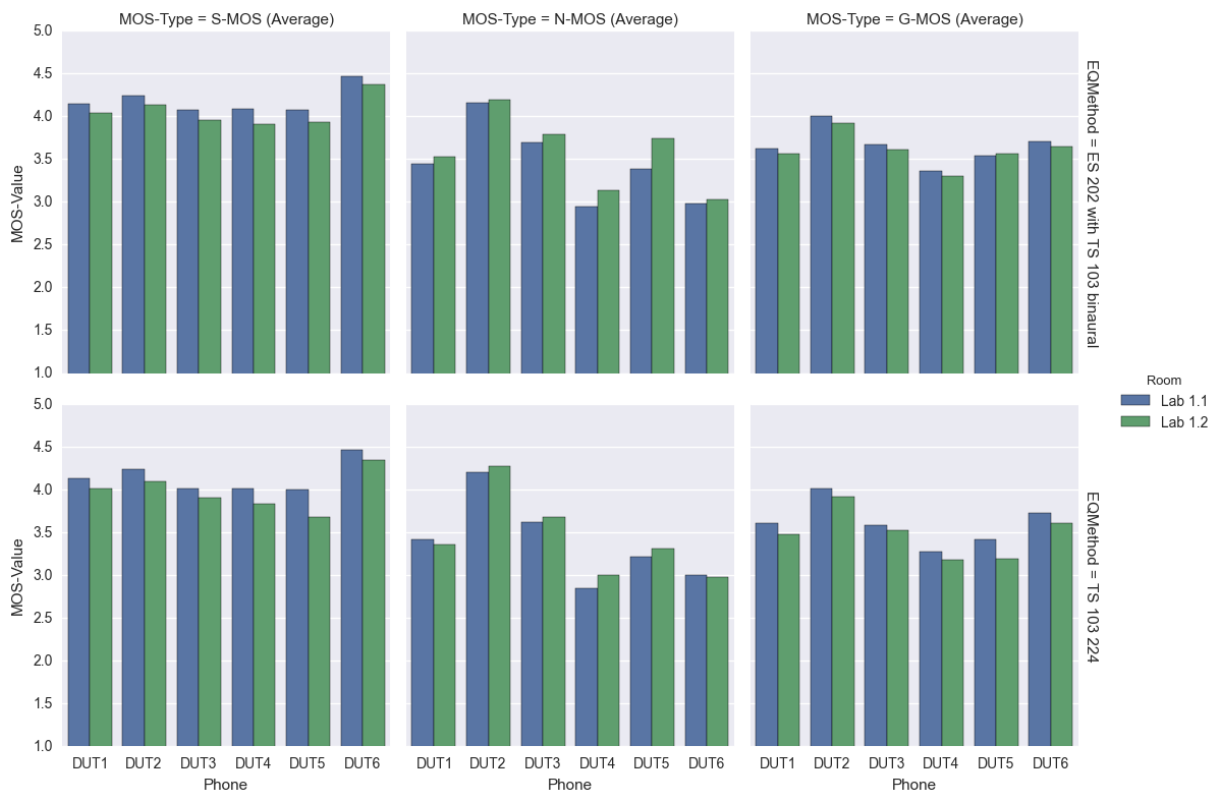

Figure 90: Absolute MOS-values for both background noise simulations in both rooms averaged over all noises (DTHF, Wideband)

3.4.2.2 Narrowband

The analysis shows the absolute MOS-values measured in the different rooms averaged over all background noises for every simulation method. The following observations can be made:

- G-MOS and S-MOS is always higher in room 1.
- N-MOS is always higher in room 2.

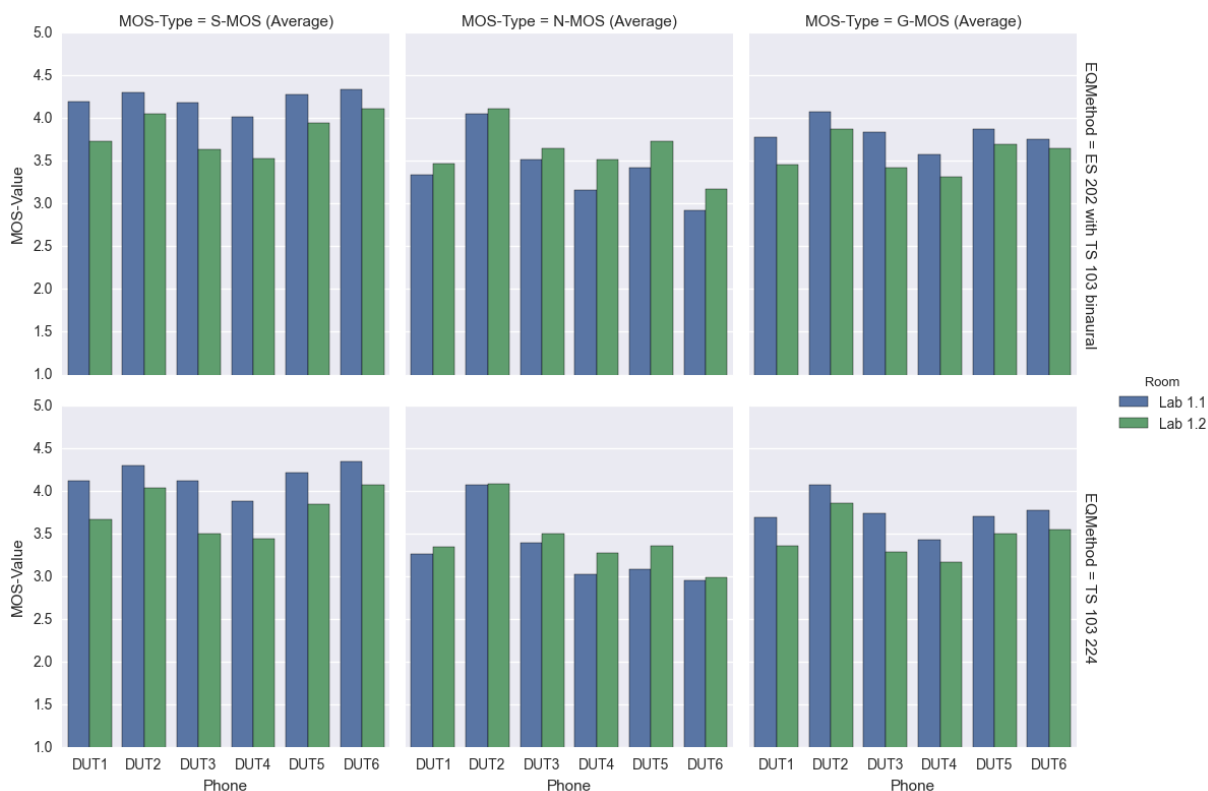

Figure 91: Absolute MOS-values for both background noise simulations in both rooms averaged over all noises (DTHF, Narrowband)

3.4.3 Analyses of the noise spectra reproduced at the reference microphone

The following two chapters show the noise spectra recorded at a reference microphone which was located close to the main microphone of the DUT. This reference is positioned close to the main microphone of the DUT microphone and is used e.g. to record the unprocessed signal plus noise for 3QUEST [10]. All available measurements for all 6 DUTs in both rooms are plotted into one diagram which means that one diagram contains 12 curves.

Again, as already observed in the HHHF case it can be seen that the differences in case of the simulation acc. to ES 202 396-1 are quite big in contrast to the differences which can be observed for the simulation acc. to TS 103 224.

3.4.3.1 Simulation acc. to ES 202 396-1

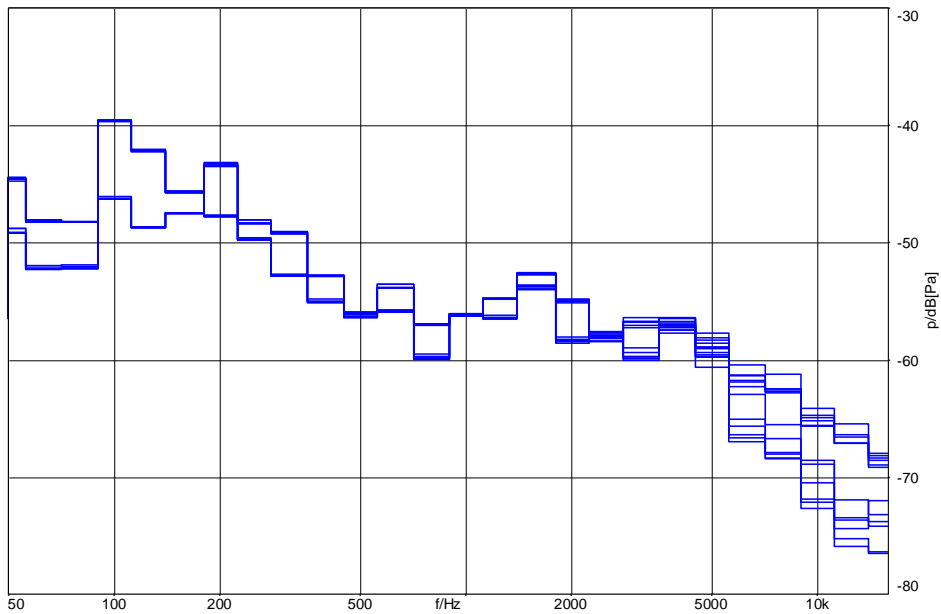

Figure 92: All spectra recorded at reference microphone for desktop office noise with method from ES 202 396-1 in 1/3rd octave (DTHF)

3.4.3.2 Simulation acc. to TS 103 224

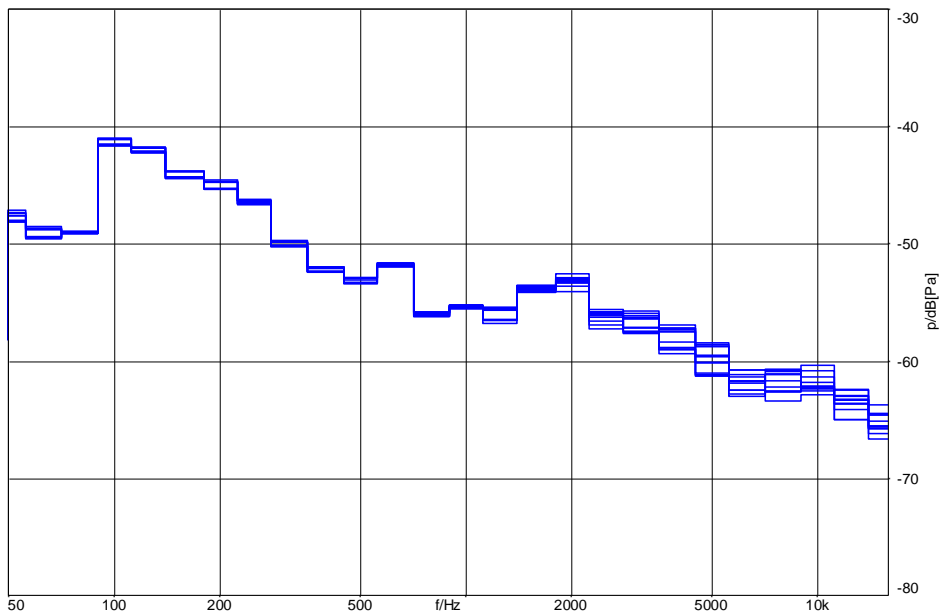

Figure 93: All spectra recorded at reference microphone for desktop office noise with method from TS 103 224 in 1/3rd octave (DTHF)

3.5 Conclusions from the hands-free tests

The conclusions we can draw from these experiments are very much in line with the findings from the 3GPP Round Robin test described in [11]. The results of the other participating labs confirm the findings described here:

- The accuracy and consistency of the background noise reproduction at the terminal is significantly better especially in the low frequency domain below 2 kHz when using 3PASS acc. TS 103 224 [2]. Spectral differences measured at the reference microphone drop from 5-15 dB when measuring in 1/3rd octaves using HAE-BGN acc. to ES 202 396-1 [1] to 1-5 dB when using 3PASS.
- When using the binaurally recorded background noises from equivalent to the TS 103 224 [2] noises the differences in average S-, N- and G-MOS when comparing HAE-BGN with 3PASS are small for the terminals used in this test. The offset is not constant but depending on the type of terminal. The performance for all terminals is measured slightly better when using HAE-BGN in hand-held HFT. For desktop HFT the variations observed are slightly bigger, the differences are not consistent. The inter-lab correlation when using 3PASS is higher than with HAE-BGN which is also confirmed by the 3GPP Round Robin experiment [11].
- Clear and bigger differences can be observed when comparing the two background simulation methods for the individual noises. Due to the less precise reproduction of the background noise field with HAE-BGN, the accuracy of the measurements is less and the measurements are less realistic.

Therefore, HEAD acoustic recommends the use of 3PASS. Especially for new hands-free designs and new algorithms the 3PASS background noise simulation will give much more realistic results and will show any superiority of new noise cancellation designs much better than 3PASS.

4 References

- [1] ETSI ES 202 396-1: Speech quality performance in the presence of background noise; Part 1: Background noise simulation technique and background noise database
- [2] ETSI TS 103 224: A sound field reproduction method for terminal testing including a background noise database
- [3] ETSI TS 103 106: Background noise transmission for mobile terminals-objective test methods
- [4] 3GPP TS 26.131: Terminal acoustic characteristics for telephony; Requirements, Rel. 13
- [5] 3GPP TS 26.132: Speech and video telephony terminal acoustic test specification, Rel. 13
- [6] Recommendation ITU-T P.64: Determination of sensitivity/frequency characteristics of local telephone systems
- [7] Recommendation ITU-T P.501: "Test signals for use in telephony"
- [8] HEAD acoustics GmbH: Manual 3PASS
- [9] HEAD acoustics GmbH: Manual HAE-BGN
- [10] HEAD acoustics GmbH: Help System ACQUA
- [11] 3GPP SA 4, Tdoc S4-151365: Results of the Round Robin Test on Different Background Noise Simulation Techniques for Hand-Held Hands-Free Terminals
- [12] ITU-T P.340: Transmission characteristics and speech quality parameters of hands-free terminals